

Original Instructions

Installation Operations and Maintenance manual

RXV/HE series

Incorporated in this manual there are the following documents:

- Declaration of conformity
- Technical schedule
- Dimensional drawing
- Wiring diagrams



Dear customer,

*We thank you for purchasing a VORTICE INDUSTRIAL product,
manufactured with first choice materials and advanced technologies.*

*The quality level is under constant control, and VORTICE INDUSTRIAL products
are therefore synonymous with Safety, Quality and Reliability.*

Vortice Industrial srl



Multiple instructions:
Consult the specific part



Read and understand
the instructions before
undertaking any work on
the unit

The Company have the right to introduce at any time whatever modifications necessary to the improvement of the product.

Reproduction, data storage and transmission, even partial, of this publication, in any form, without the prior written authorisation of Vortice Industrial S.r.l., is prohibited. Vortice Industrial S.r.l. can be contacted for all inquiries regarding the use of its products.

Vortice Industrial S.r.l. follows a policy of continuous product development and improvement and reserves the right to modify specifications, equipment and instructions regarding use and maintenance at any time, without notice.

Declaration of conformity (FAC-SIMILE)

We declare under our own responsibility that the units and the equipment complies in all parts with the CEE and EN directives. The CE declaration of conformity is enclosed to the technical schedule enclosed with the unit.

This units has been designed in accordance with the following EU Directives:

- **Directive 2006/42/CE** of the European Parliament and of the Council of May 17th, 2006 on machinery;
- **Directive 2014/35/CE** Low Voltage by achievement of the following technical standards: EN 60335-2-40:2003 + A11:2004 + A12:2005 + A1:2006 + EC:2006 + A2:2009 + A13:2012 + A13/EC:2013, EN 60335-1:2002 + A11:2004 + A1:2004 + A12:2006 + A2:2006+ A1/EC:2007 + A13:2008 + EC:2009 + EC:2010 + A14:2010 + A15:2011;
- **Directive EMC 2014/30/UE** of the European Parliament and of the Council of February 26th, 2014 on the harmonisation of the laws of the Member States relating to electromagnetic compatibility (recast), by achievement of the following technical standards: EN 60335- 1:2012, EN 55014-1:2006 + A1:2009 + A2:2011, EN 61000-3-2:2006 + A1:2009 + A2:2009, EN 61000-3-3:2013, EN 55014-2:1997 + A1:2001 + A2:2008;
- **Directive RoHS 2011/65/UE**;
- **Directive 2010/30/UE** relating to energy labelling;
- **Directive 2009/125/UE** with implementing regulation D. Lgs. n. 15 of February 16th, 2011 and the following harmonised standard: EN 60204-1:2018



The unit is equipped with a series of prevention and safety devices described in detail in the accompanying documentation. The installer is required to connect and activate all these mounted components, checking their functionality.



The system or machine into which this unit is to be incorporated must also comply with the above mentioned Directives. The user, or whoever subsequently operates the system, must periodically check the functionality and efficiency of the safety devices.



The non-activation, removal or inhibition of the active safety systems, as well as the removal of the passive safety systems, exempt Vortice Industrial s.r.l. from any responsibility regarding any accident or damage, direct or indirect, to people and/or things, attributable to the machine.



The manual supplied with the unit is completed by a TECHNICAL DATA SHEET, with the fundamental constructive and functional data, and by the relative DRAWINGS.



Transport, handling, installation and subsequent operation must be carried out in full compliance with the above prescriptions, in the subsequent indications of the manual and the accompanying documentation.



Corporate Technical Management
Zecchin Maurizio

Service provided by Vortice Industrial s.r.l.
e-mail: info@vorticeindustrial.com

GENERAL INDEX

- 1. INTRODUCTION..... 06
 - 1.1 General information 06
 - 1.2 Purpose and Content of the Instructions..... 06
 - 1.3 Storage of instructions 06
 - 1.4 Instructions update 06
 - 1.5 How to use these instructions 06
 - 1.6 Residual Risks 07
 - 1.7 General Safety Symbols..... 09
 - 1.8 Safety Symbols..... 10
 - 1.9 Limits of use and prohibited uses 11
 - 1.10 Unit identification..... 11
- 2. TECHNICAL CHARACTERISTICS 12
 - 2.1 Introduction..... 12
 - 2.2 Structure..... 12
 - 2.3 Heat recovery 12
 - 2.4 Fans..... 12
 - 2.5 Test..... 12
 - 2.6 Packing..... 12
- 3. VERSIONS 13
 - 3.1 Version ECO 13
 - 3.2 Version PLUS..... 13
 - 3.3 Version TOP 13
- 4. CONFIGURATIONS..... 14
- 5. MAIN COMPONENTS OF THE UNIT 15
- 6. AVAILABLE ACCESSORIES 16
- 7. OPERATING MODE 18
 - 7.1 Winter operating mode..... 18
 - 7.2 Summer operating mode 18
 - 7.3 Free-Cooling operating mode 18
- 8. TECHNICAL DATA..... 19
- 9. VENTILATION CURVES 20
- 10. OPERATING LIMITS..... 22
- 11. SOUND DATA 23
 - 11.1 Noise levels..... 23
 - 11.2 Sound attenuators reduction 23
- 12. SAFETY AND CONTROL DEVICES..... 24
- 13. INSTALLATION 25
 - 13.1 Receipt and inspection 26
 - 13.2 Storage..... 26
 - 13.3 Unpacking..... 26
 - 13.4 Lifting and Handling 27
 - 13.5 Positioning and minimum technical spaces..... 27
 - 13.6 Connecting additional sections: Sound attenuators..... 28
 - 13.7 Condensate drain connection 28
 - 13.8 Hydraulic connection to the water coil..... 29
 - 13.9 How to vent the unit 29
 - 13.10 Connecting the unit to air ducts 30
 - 13.11 Filters and heat exchanger access 31

- 14. RS485 SERIAL INTERFACE CARD..... 32
- 15. CO2 PROBE 32
- 16. ELECTRICAL CONNECTIONS 33
 - 16.1 Electrical data 34
 - 16.2 Power supply connection 34
 - 16.3 Terminal Block Connections 35
 - 16.4 Detail of electrical panel 37
- 17. STARTUP 37
 - 17.1 Preliminary checks 37
 - 17.2 Description of the controller 38
- 18. UNIT USE 39
 - 18.1 Turn ON the unit and setting parameters 39
 - 18.2 Set "Real Time Clock" (RTC)..... 40
 - 18.3 Set operation by time bands 41
 - 18.4 Enable control with CO2 air quality sensor 42
 - 18.5 Enabling reversible mode of the cooling coil 43
 - 18.6 Alarms display and reset 44
- 19. DIAGNOSIS AND TROUBLESHOOTING 45
 - 19.1 Troubleshooting 45
- 20. DIMENSIONAL DRAWINGS..... 46
- 21. UNIT MAINTENANCE 48
 - 21.1 General warnings 48
 - 21.2 Access to the unit 48
 - 21.3 Periodical checks 48
- 22. DECOMMISSIONING 49
 - 22.1 Disconnecting the unit 49
 - 22.2 Decommissioning, disposal and recycling 49
 - 22.3 RAEE Directive (EU only) 49

1. INTRODUCTION

Units must be installed and operated according to the instructions in this manual. Strict adherence to these simple instructions is a prerequisite to:

- eliminate or reduce shutdown time due to unexpected failures;
- improve the performance of components, resulting in energy savings;
- increase the life of components and the entire unit;
- decrease maintenance costs.

1.1 General information

This manual has been prepared to allow correct installation, set-up and maintenance of the unit. Any contractual or extra-contractual responsibility of the Company for damage caused to persons, animals or things, due to installation, adjustment and maintenance errors or improper use, is excluded. Any use other than that specified does not imply for the manufacturer any commitment or obligation of any kind.

This documentation is an informative support and cannot be considered as a contract towards third parties.

The Company implements a policy of constant improvement and development of its products. It therefore reserves the right to make changes to specifications, fittings and documentation at any time, without prior notice and without any obligation to update what has already been delivered.

1.2 Purpose and Content of the Instructions

These instructions provide essential information for the installation, operation, testing and maintenance of the machine. They have been drawn up in accordance with the legal provisions issued by the European Union and the technical standards in force at the time the instructions were issued.

The local safety regulations in force at the time of installation must be observed.

The instructions contain instructions for avoiding reasonably foreseeable misuse.

1.3 Storage of instructions

This manual and the eventual wiring diagram of the unit must be carefully stored in a suitable place, protected from dust and humidity and easily accessible to users and operators for any further consultation.

The instructions must always follow the unit throughout its entire life cycle and must therefore be passed on to any subsequent user.

1.4 Instructions update

It is recommended to check that the instructions are up to date with the latest revision available.

Any updates sent to the customer should be retained as an attachment to this manual.

The Company is available to provide any information regarding the use of its products.

1.5 How to use these instructions



The instructions are an integral part of the unit.



It is compulsory for users or operators to consult the instructions before any operation on the unit and on any occasion of uncertainty regarding the transport, handling, installation, maintenance, use and dismantling of the unit.

In these instructions, in order to draw the attention of operators and users to the operations to be carried out in safety, graphic symbols have been included that are shown in the following paragraphs.

1.6 Residual Risks

A residual risk is any hazard that cannot be fully reduced by design and protective techniques, or a potential hazard that is not obvious.



ATTENTION

This manual indicates any operation that may generate a hazardous situation as well as the precautionary measures to be observed in each case.

- All units have pictograms with hazard warnings.
- The units are safe machines, provided the safety guards are not tampered with or removed.
- Technical preparation, observance of the procedures outlined in this manual, and markings at critical points on the unit will still allow safe operation.
- The following safety rules must be observed during installation, start-up, use and maintenance of the units:



- Do not operate the unit unless it and its electrical components have been connected to the earthing system;
- Do not operate unit unless fan is connected to a duct or protected with safety mesh;
- Do not use the unit as a stand for other machinery;
- Do not use unit as a walkway;
- Do not use unit as equipment storage;
- Do not open inspection panels while fan is running, especially in over pressure sections;
- Do not leave inspection panels partially closed; Make sure all handles or knobs are securely closed;



- Wear personal protective equipment before working on the unit;



- Before accessing the unit, make sure that all electrical utilities have been turned off, especially before opening the inspection panels, make sure that the fan is off and cannot be turned on again without the knowledge of the person working on the unit;



- Before starting the fan, always refit the protection cover or the closing panel of the fan section;



- Be careful when lifting the unit as its center of gravity may be severely unbalanced;
- Be careful when locking the lifting ropes/hooks;
- Be careful of sheet metal edges inside the unit;
- Be careful of sheet metal edges outside the unit;
- Be aware of possible burns from heating coils;
- Be aware of dampers that may close unexpectedly.

Whilst the unit has been designed to minimize any risk posed to the safety of people who will interact with it. It has not been technically possible to eliminate completely the causes of risk. It is therefore necessary to refer to the requirements and symbolism below.

LOCATION OF RISK (if present)	RESIDUAL RISK	METHOD OF INJURY	PRECAUTIONS AND PROTECTIONS
Mixing box with dampers and actuators	Crush	Contact	Remove voltage before any operation
Thermal heat exchangers	Small stab wounds, burns	Contact	Avoid any contact, use protective gloves
Electric heaters	Electrocution, severe burns	Contact, Fire due to short circuit or overheating of the heating elements	Periodic check of the safety devices, adhesive warning signs on the machine
Heat exchangers	Small stab wounds, crush	Contact	Avoid any contact, use protective gloves
Fans	Cuts, eye damage, broken bones	Insertion of objects through the fans are operating	Never put objects through the fans sections
External to unit: unit enclosure	Intoxication, severe burns	Fire due to short circuit or overheating of the supply cable external to unit	Size cables and mains protection system in accordance with standards regulations
Internal component: electric cables and metallic parts	Electrocution, severe burns	Defect in the supply cable insulation, live metallic parts	Adequate protection of power cables, ensure correct earthing of all metal parts

1.7 General Safety Symbols

Individual safety symbols in accordance with ISO 3864-2:

**PROHIBITION**

A black symbol inserted in a red circle with a red diagonal indicates an action that must not be performed.

**WARNING**

A black graphic symbol within a yellow triangle with black borders indicates a hazard.

**MANDATORY ACTION**

A white symbol inserted in a blue circle indicates an action that must be performed to avoid a hazard.

Combined safety symbols in accordance with ISO 3864-2:



The graphic symbol “warning” is qualified with additional safety information (text or other symbols).

1.8 Safety Symbols



GENERAL DANGER

Strictly observe all indications placed beside the pictogram. Failure to observe the indications may lead to situations of risk with possible consequent damage to the health of the operator and the user in general.



ELECTRICAL HAZARD

Observe all signs placed next to the pictogram. The symbol indicates components of the unit and actions described in this manual that could create an electrical hazard.



MOVING PARTS

The symbol indicates those moving parts of the unit that could create risk.



SHARP SURFACES

The symbol indicates components or parts that could cause stab wounds.



EARTH CONNECTION

The symbol identifies earthing connection points in the unit.



READ AND UNDERSTAND THE INSTRUCTIONS

Read and understand the instructions of the machine before any operations.



RECOVER OR RECYCLE MATERIAL

1.9 Limits of use and prohibited uses

The machine has been designed and built exclusively for the uses described in the technical manual. Any other use is prohibited as it could generate health risks for the operators and users.



However, the unit is not suitable for operation in environments:

- where vibrations are present;
- where electromagnetic fields are present;
- where aggressive atmospheres are present.





THIS UNIT IS NOT SUITABLE FOR OPERATION IN EXPLOSIVE ATMOSPHERE.

1.10 Unit identification

Each unit has a label attached to the outside of the unit, which shows the identification data of the machine together with the main technical characteristics.

For electrical information not included on the label, refer to the electrical diagram. Check that the characteristics of the electrical network comply with the data on the identification plate.

A FAC-SIMILE of the nameplate is shown below with the relative caption of the data::

		VORTICE INDUSTRIAL S.R.L. via Bernardino Brugnoni, 3 37063 Isola della Scala Verona (Italy) - Tel. +39-045 6631042  vorticeindustrial.com	
NRVU UNIT MODEL	<input type="text" value="1"/>		
POWER SUPPLY	<input type="text" value="2"/>		
NOMINAL AIR FLOW	<input type="text" value="3"/>		
EC FAN SUPPLY SIDE		EC FAN EXHAUST SIDE	
POWER INPUT	<input type="text" value="4"/>	POWER INPUT	<input type="text" value="7"/>
RATED CURRENT	<input type="text" value="5"/>	RATED CURRENT	<input type="text" value="8"/>
USEFUL EXT. PRESS.	<input type="text" value="6"/>	USEFUL EXT. PRESS.	<input type="text" value="9"/>
MAX. ELECTRIC CURRENT			<input type="text" value="10"/>
MAX. CURRENT WITH ELECTRIC HEATER			<input type="text" value="11"/>
WEIGHT	<input type="text" value="12"/> + <input type="text" value="13"/>	 	
MADE IN ITALY			
SERIAL NUMBER	<input type="text" value="14"/>	PART CODE	<input type="text" value="15"/>
MANUFACTURED PERIOD	<input type="text" value="16"/>		

CAPTION:

- (1) Unit model and size
- (2) Power supply characteristics
- (3) Nominal air flow
- (4) Electric power input on supply side
- (5) Rated current on supply side
- (6) External static pressure on supply side
- (7) Electric power input on exhaust side
- (8) Rated current on exhaust side
- (9) External static pressure on exhaust side
- (10) Max. electric current consumption
- (11) Max. current consumption with electric heater
- (12) Main unit weight
- (13) Coils add-on module weight
- (14) Serial number
- (15) Unit part code
- (16) Manufactured period

For each support request to the Company it is essential to always quote the model and serial number indicated on this plate (ref. 1 and 14).



The identification label must never be removed from the unit.

2. TECHNICAL CHARACTERISTICS

2.1 Introduction

The sick building syndrome is a disease recognized by the World Health Organization that presents a series of symptoms due to the presence of toxic elements in the workplace. The main sources of pollution originate both from factors inside and outside the building.

Replacing the air, not wasting energy, is the solution. Thanks to the installation of Controlled Mechanical Ventilation systems it is possible to guarantee the correct air exchange and filtration.

The heat recovery units provide the air exchange together with the recovery of a part of the thermal energy of the extracted air which is given to the fresh air at practically no cost; therefore a pre-heating in winter or a pre-cooling in summer of the introduced air is obtained, moreover they bring other advantages such as air filtration and a smaller sizing of the heating and cooling systems, allowing savings both during the purchase and the conduction of the same.

The units are available in 7 sizes, with nominal air flow rates from 400 to 4000 m³/h.

The units have been designed for ground installation (V), with vertical air flows.

All configurations are available in the **ECO, PLUS, TOP** version.

2.2 Structure

Structure in RAL 9010 steel profiles, pre-painted at 180°C with polyurethane powder paint and 50 mm thick panels.

Sheets with 6/10" thickness covered with protective film, in galvanized steel.

The internal insulation is made of high density polyurethane foam (40 kg/m³). The casing is made according to EN1886 standard, class D1 mechanical strength.

The air tightness is guaranteed by a particularly adaptable and resilient neoprene gasket, the tightening of the opening panels is made by means of push screws that ensure an adequate and constant pressure on the gaskets. In all areas subject to condensation there is a condensation tray, inclined internally and in compliance with EN 1.4301. All internal components are frontally accessible through removable panels to ensure proper routine and extraordinary maintenance.

2.3 Heat recovery

The units are equipped with an aluminium counter-flow heat exchanger used to transfer heat from the exhaust air to the fresh air. The spacing between the fins is optimised in order to reduce air side pressure drop and fan power consumption.

The heat recovery is also equipped with an additional by-pass damper for the management of the free-cooling and free-heating mode as per ERP regulation. By-pass damper 100% of the airflow rate.

2.4 Fans

Independently controllable, they are made up of centrifugal impellers with reversed blades, directly coupled to electronically commuted bearing motors (EC brushless), external rotor, single-phase or three-phase (depending on the model), integral thermal protectors and able to adapt the performance to the needs of the moment (modulating air flow regulation), ensuring low consumption and reduced noise emissions.

2.5 Test

Units are fully assembled and wired at the factory and subjected to a complete functional test before shipment. They are manufactured in compliance with the safety standard of the Machinery Directive 2006/42/EC, the Low Voltage Directive 2006/95/EC, and the Electromagnetic Compatibility Directive 2004/108/EC and therefore complies with the "Health and safety requirements" prescribed. Units are provided with CE markings, certificate of conformity, user and maintenance manual.

2.6 Packing

Units are supplied on thick wooden pallets and wrapped in plastic film to protect against impacts during transport and handling on site.

3. VERSIONS

3.1 Version ECO

ECO: complete with air temperature sensors installed on the fresh air intake and on room return air. The control allows to select, in stepless mode, the supply and return fan speeds and automatically manages the heat recovery by-pass damper through the motorized On/Off control, summer/winter seasonal change over, and programming for daily time zones.

An optional hot water or cold water coil may also be managed, controlled by a 3-way modulating valve through the room return air sensor.

3.2 Version PLUS

PLUS: this control option is set to operate at constant pressure, it is supplied complete with pressure transducer and air temperature sensors installed on the fresh air intake and room return air.

The control system allows to select, in stepless mode, the supply and return fan speeds and automatically manages the heat recovery by-pass damper through the motorized On/Off control.

It also manages the summer/winter seasonal change over and programming for daily time zones.

The control can also manage an optional hot water or cold water coil through a 3-way modulating valve and an additional supply air sensor in order to maintain a fixed point operating logic.

3.3 Version TOP

TOP: this control option is set to operate at constant air-flow, it is supplied complete with pressure transducer and air temperature sensors installed on the fresh air intake and room return air.

The control system allows to select, in stepless mode, the supply and return fan speeds and automatically manages the heat recovery by-pass damper through the motorized On/Off control.

It also manages the summer/winter seasonal change over and programming for daily time zones.

The control can also manage an optional hot water or cold water coil through a 3-way modulating valve and an additional supply air sensor in order to maintain a fixed point operating logic.



REMOVABLE CONTROL PANEL

All units are supplied complete with a removable control panel with LCD graphic display.

The clean and modern lines and the installation options, panel or wall mounted (with its own power supply or from a controller), make them easy to integrate into any type of environment.

4. CONFIGURATIONS

V1

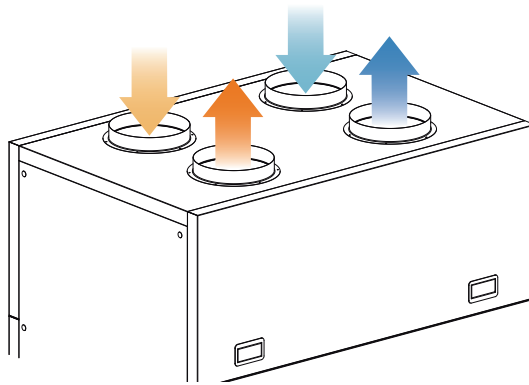

V2

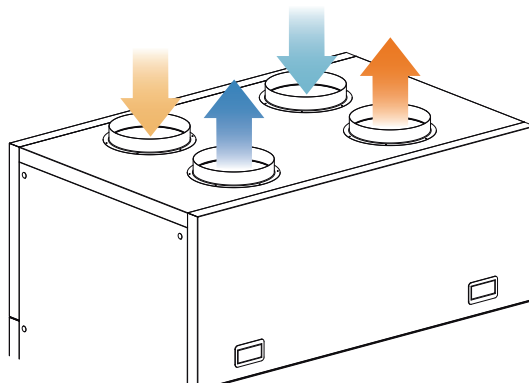

V3

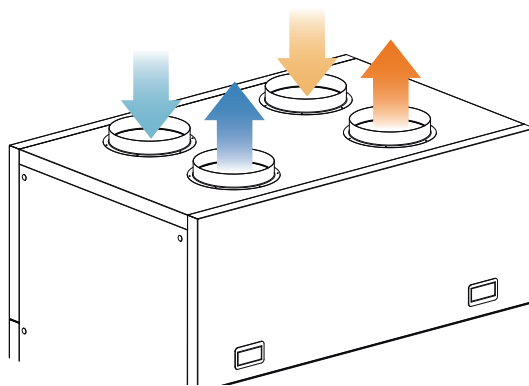

V4

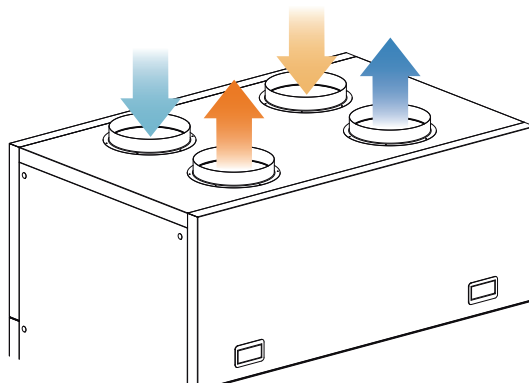

— RETURN AIR
— EXHAUST AIR

— FRESH AIR INLET
— SUPPLY AIR

5. MAIN COMPONENTS OF THE UNIT

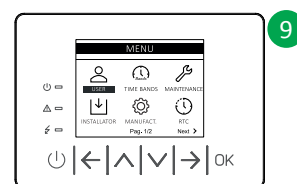
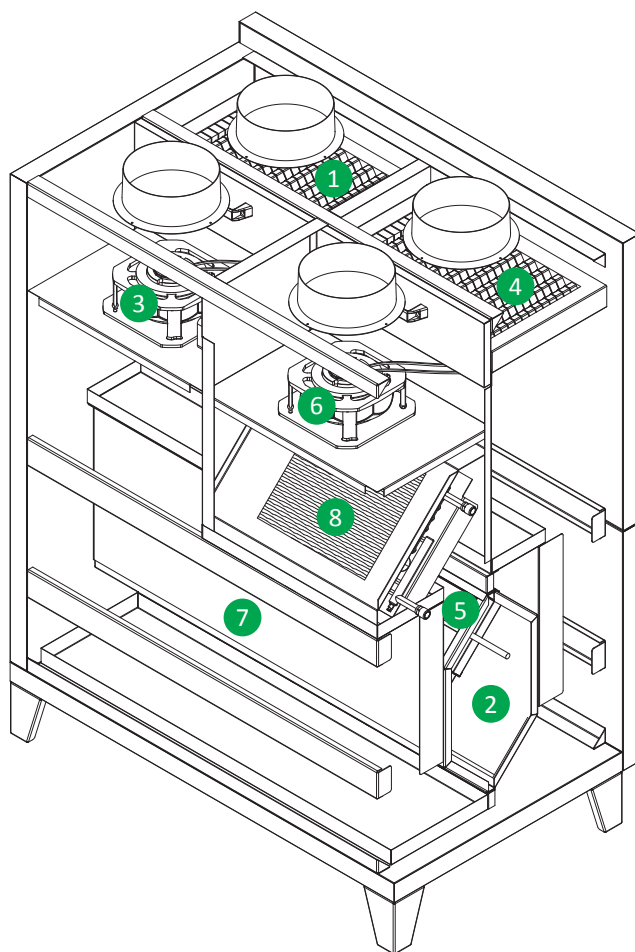

1	Return air filter	7	Electrical panel
2	Counterflow heat exchanger	8	Hydronic coils ⁽¹⁾ (heating / cooling)
3	Backward blade fan, EC brushless motor with external rotor (exhaust side)	9	Removable control panel with LCD graphic display
4	Fresh air inlet filter		
5	By-Pass damper on heat exchanger		
6	Backward blade fan, EC brushless motor with external rotor (supply side)		

⁽¹⁾ component supplied on request as an accessory

6. AVAILABLE ACCESSORIES

ISO coarse 40% (G2) grease pre-filter

It is built with galvanized sheet metal frame, filtering media in galvanized wire tubular sock, 48mm thickness, contained by two welded galvanized nets. The filter is used in the presence of dust and large pollutants suspended in the air or in case of filtration of oily mists. It may be installed as pre-filter in combination with the ePM₁₀ 60% (M5), ePM₁ 55% (F7) or ePM₁ 80% (F9) filters, located on the room air return side.

ePM₁₀ 50% (G4) air pre-filter

Made of galvanized steel sheet frame and undulated filter media, 48mm thickness, in white synthetic material, contained by two welded galvanized nets. The filter media has a low pressure drop and it may be installed as pre-filter in combination with the ePM₁₀ 60% (M5), ePM₁ 55% (F7) or ePM₁ 80% (F9) filters, located on the room air return side.

ePM₁₀ 60% (M5) air filter

Built with a galvanized sheet metal frame and a 48 mm thick pleated filtering sieve, in white fiberglass, contained by two welded galvanized nets. The filter media has an ePM₁₀ 60% (M5) filtering degree, according to ISO 16890 and has a large filtering surface area that guarantees long operating life and less frequent replacements.

eMP₁ 55% (F7) air filter

Built with a galvanized sheet metal frame and a 48 mm thick pleated filtering sieve, in white fiberglass, contained by two welded galvanized nets. The filter media has an ePM₁ 55% (F7) filtering degree, according to ISO 16890 and has a large filtering surface area that guarantees long operating life and less frequent replacements.

eEPM₁ 80% (F9) air filter

Built with a galvanized sheet metal frame and a 48 mm thick pleated filtering sieve, in white fiberglass, contained by two welded galvanized nets. The filter media has an ePM₁ 80% (F9) filtering degree, according to ISO 16890 and has a large filtering surface area that guarantees long operating life and less frequent replacements.

Additional filter rails

The additional filter rails are used when a second filter, in series with the one used as standard, is required.

Electric defrost system

The automatic defrost system (optional) consists of a self-regulating electric coil in PWM input power mode, installed on the return air intake. The system is controlled by a special temperature probe positioned on the exhaust air and guarantees a considerable reduction of the input power compared to traditional systems available on the market.

Unbalanced airflows defrost system

The defrost system (optional) consists of a specific device and software that avoid an excessive drop of the exhaust air temperature slowing down the supply and return airflow and, in case the opening of the by-pass damper. This system is normally supplied in combination with the hot water coil (optional).

Electric re-heating battery (internal)

All units may be equipped with an internal re-heating electric battery, made up of armoured steel electric heaters, supplied complete with PWM control system, safety thermostat already wired and installed on board.

Hot water coil (internal)

The hot water coil is manufactured with copper pipes thickness 0,4 mm and aluminium fins thickness 0,11 mm. The pipes are mechanically expanded in the aluminium fins to increase the thermal exchange rate. On request, it is possible to install coils with different capacities from the standard ones, when previously agreed with the factory.

Cold water coil (internal)

The cold water coil is manufactured with copper pipes thickness 0,40 mm and aluminium fins thickness 0,11 mm. The pipes are mechanically expanded in the aluminium fins to increase the thermal exchange rate. On request, it is possible to install coils with thermal performances different from the standard ones, when previously agreed with the factory. The cooling coil section is supplied complete with condensate drain pan.

3 way modulating valve

It consists of a kit including the 3-way valve for the control of the water flow, to be combined with the hot and/or cold water coil, and its modulating electric actuator.

Connection and fitting devices not included (to be arranged for by the installer).

Air damper with actuator

This is installed on board the unit and operates to exclude the fresh air intake and/or the room return air flow. This option is particularly useful in areas with very cold winter temperatures, where it is necessary to avoid dangerous self-induced cold air flows by the installation itself, during the stand-by period of the unit, with the risk of freezing the water contained in the water coils, if any. The damper is controlled by On/Off actuator for the opening or the closing, or with return closing spring.

Sound attenuator

The sound attenuator consists of a cylindrical section made in galvanized steel sheet, containing a mineral wool soundproofing material covered with glass wool jacket and perforated galvanized steel sheet containment. The soundproofing material is class M0. The construction avoids any risk of mineral wool fraying even at high air speeds.

The cylindrical section is fixed to the unit by screws.

CO₂ probe

ECO version units can be equipped with air quality CO₂ probe. This accessory is installed and wired in the factory.

If it's installed on the return air duct it allows to determine the quantity of carbon dioxide present in the environment, increasing the quantity of external air to dilute its content.

ATTENTION: The CO₂ probe is not available in PLUS and TOP versions.

7. OPERATING MODE

7.1 Winter operating mode

The return air from the room, with a higher thermal load than the fresh air, crosses the plate heat exchanger, where it gives up part of its thermal load and cools down before being exhausted. The fresh air, with a lower thermal load than the return one from the room, crosses the plate heat exchanger in the opposite direction and heats up before the introduction into the room.

The modulation of the airflow rate, through variation of the rotation speed of the EC fans, will allow a precise control of the supply air temperature.

During winter operation, in particular working conditions with low external temperatures, the heat exchanger could be subject to the formation of surface frost with consequent loss of efficiency.

To prevent this from happening, the unit provides for the controlled management of an automatic defrosting cycle, obtained by means of a self-regulated electric battery in PWM mode, installed on the room air intake.

The system increases the temperature of the exhaust air thus avoiding the risk of frost on the heat exchanger.

The system is controlled by a specific temperature probe positioned on the air outlet and guarantees a considerable reduction of the power absorbed by the unit, compared to the traditional systems on the market.

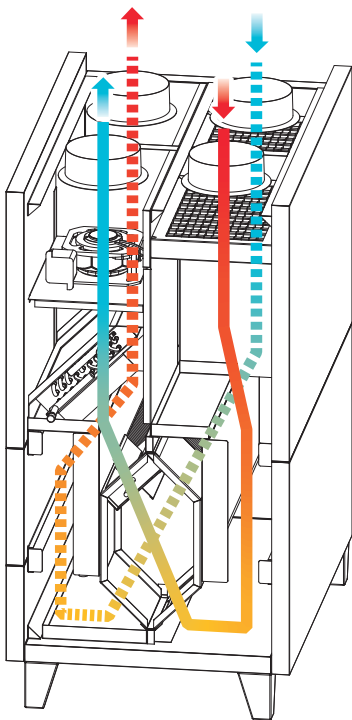
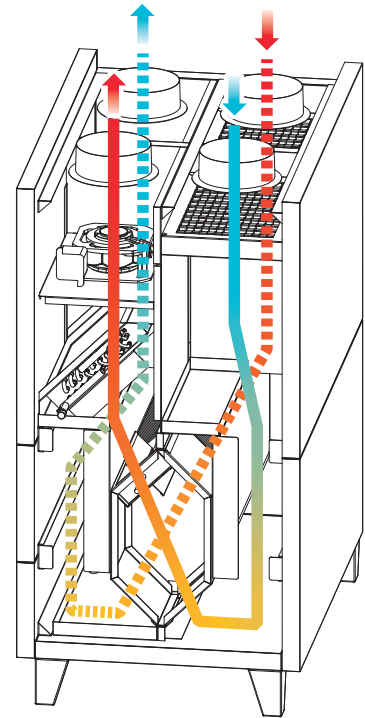

7.2 Summer operating mode

The return air from the room, with a lower thermal load than the fresh air, crosses the plate heat exchanger, where it takes part of its thermal load and heats up before being exhausted.

The fresh air, with a higher thermal load than the room air, crosses the plate heat exchanger in the opposite direction and cools down before the introduction into the room. The modulation of the airflow rate, by varying the rotation speed of the EC fans, will allow a precise control of the supply air temperature.

7.3 Free-Cooling operating mode

When the outdoor air temperature is lower than the temperature of the room to be air-conditioned and if the latter requires cooling, the unit operates in Free-Cooling mode by opening the By-Pass damper positioned on the plate heat exchanger and thus allowing the entry of outdoor air without heat recovery.

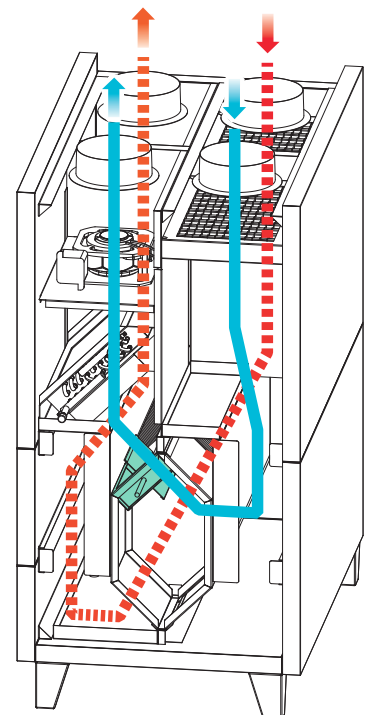

8. TECHNICAL DATA

MODEL		005	006	010	015	020	030	040	
Type of ventilation unit		UVNR-B (Non Residential Ventilation Units - Bidirectional)							
Type of drive installed		Analog signal on EC fan (0-10Vdc)							
Type of fans	type/nr.	EC/2	EC/2	EC/4	EC/4	EC/2	EC/2	EC/2	
Type of heat recovery system (HRS)	type/nr.	static counter-flow / 1							
Winter Thermal Efficiency (η_{t_nrvu}) ⁽¹⁾	%	80,8	81,4	81,6	81,8	82,0	82,2	82,0	
Winter Thermal Efficiency ⁽²⁾	%	88,0	88,4	88,5	88,7	88,9	89,0	88,9	
Nominal airflow rate	m ³ /h	410	650	1000	1620	2150	3040	3980	
Electrical power consumption	kW	0,15	0,22	0,35	0,56	0,82	1,32	1,58	
Installed electrical power	kW	0,35	0,35	0,70	0,72	1,16	1,56	2,29	
SFP _{int}	W/(m ³ /s)	786	580	714	764	840	1011	1004	
SFP _{lim} 2018	W/(m ³ /s)	1318	1326	1315	1297	1282	1248	1206	
Front speed at design range	m/s	2,18	1,61	2,03	2,14	1,93	2,21	2,41	
External nominal pressure $\Delta p_{s, ext}$ ⁽³⁾	Pa	150	150	150	150	150	150	150	
Internal pressure drop $\Delta p_{s, int}$ Supp./ Ret.	Pa	203/178	141/120	187/166	238/208	230/209	279/229	334/301	
Fans static efficiency (UE) n.327/2011	%	48,4	45,2	49,4	53,0	52,2	50,5	62,9	
Max. external / internal leakage percentage	%	max 3,5 % at -400 Pa max 5,0 % at +250 Pa							
Energy classification filters		ePM1 55% (F7) ePM10 60% (M5)							
Filter pressure switch		present							
Sound power level ⁽⁴⁾	dB(A)	63	71	69	76	80	84	84	
Sound pressure level ⁽⁵⁾	dB(A)	49	57	54	60	64	67	67	
Power supply	V/ph/Hz	230/1/50					400/3/50		

⁽¹⁾ ratio between the thermal gain of the inlet air (0 °C) and the thermal loss of the exhaust air (20 °C), both referred to the external temperature, measured under dry reference conditions, with balanced mass flow and a thermal difference of the internal/external air of 20K, excluding the thermal gain generated by the fan motors and the internal leakage, in accordance with the provisions of attached V of EU Regulation No 1253/2014

⁽²⁾ outside air: -5 °C / 80 % RH - Inside air: 20 °C / 50 % RH

⁽³⁾ performance with clean filters

⁽⁴⁾ sound power level calculated in accordance with EN 3744

⁽⁵⁾ sound pressure level measured at 1 m free field distance, in accordance with EN 3744

9. VENTILATION CURVES

The graphs below indicate the operating limits of the EC fans installed on the units.

Consider the static pressure shown as available for ductwork, having a unit equipped with ePM₁₀ 60% (M5) filters on the return side and ePM₁ 55% (F7) on the supply side.



The operating limits of the units may vary depending on the configuration and the components installed. For different unit configurations, please refer to the selection software or contact the company.

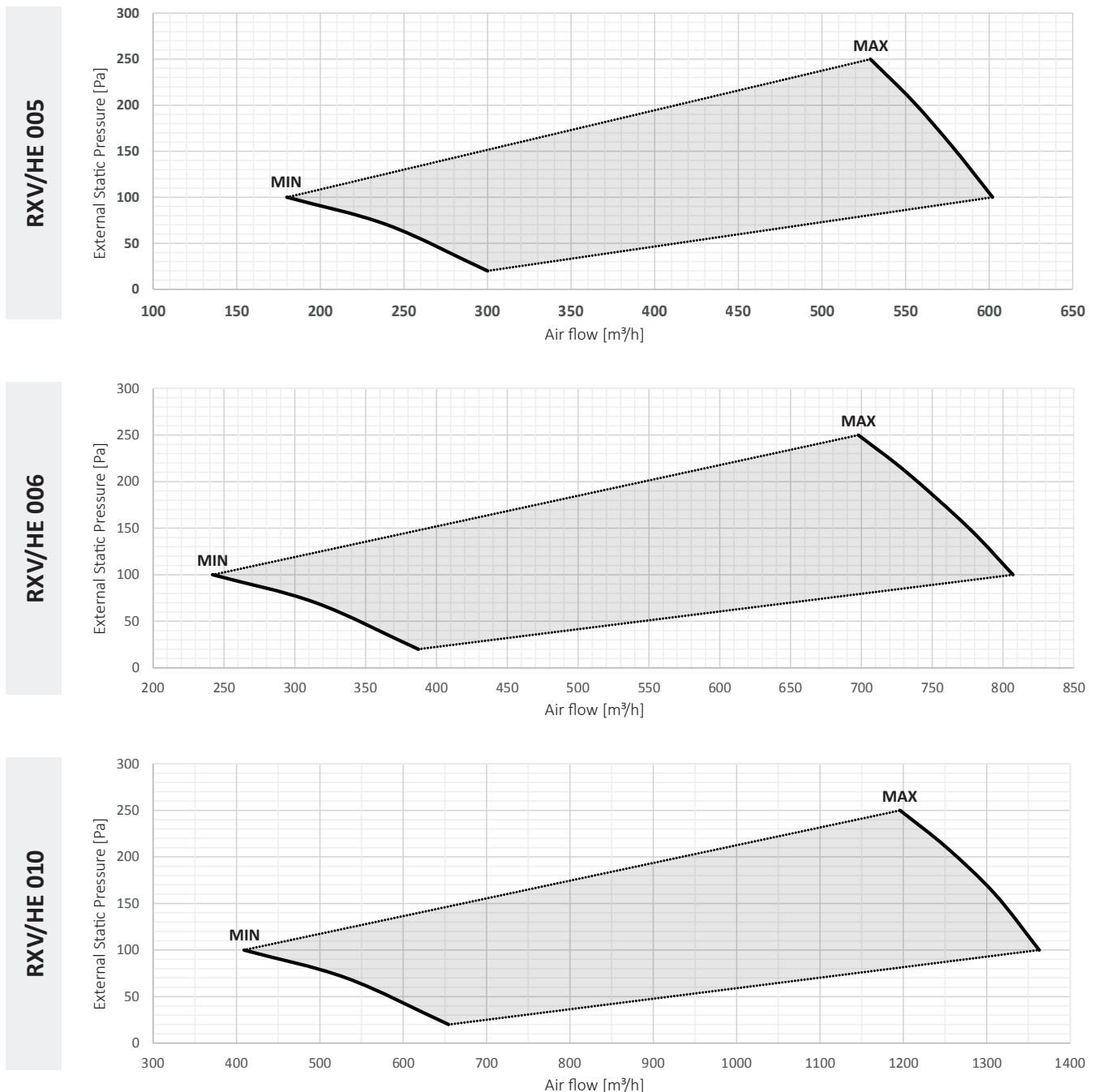

RXV/HE 015

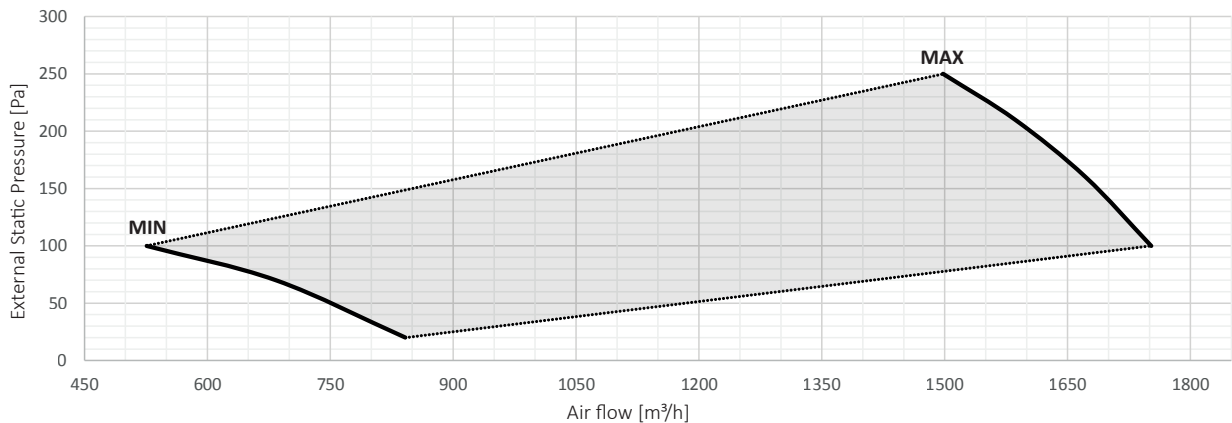

RXV/HE 020

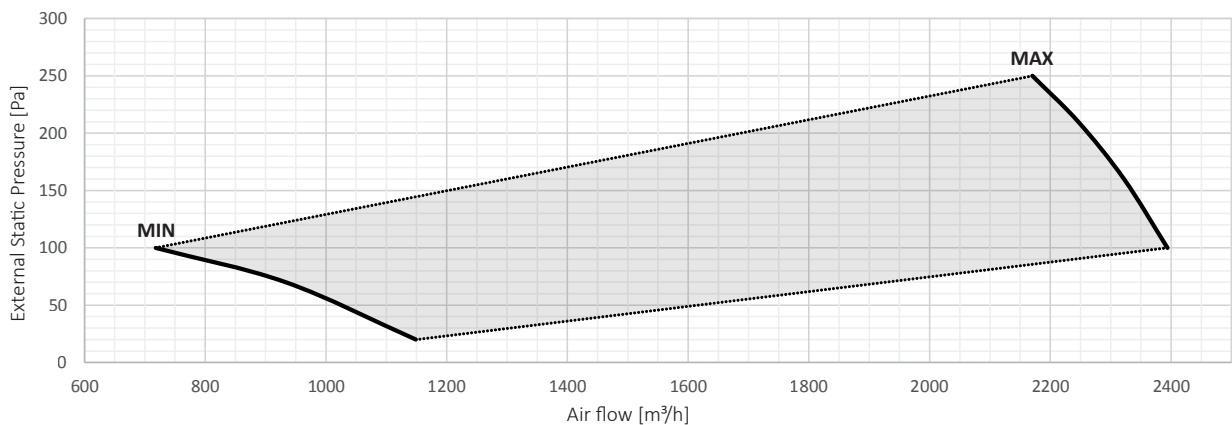

RXV/HE 030

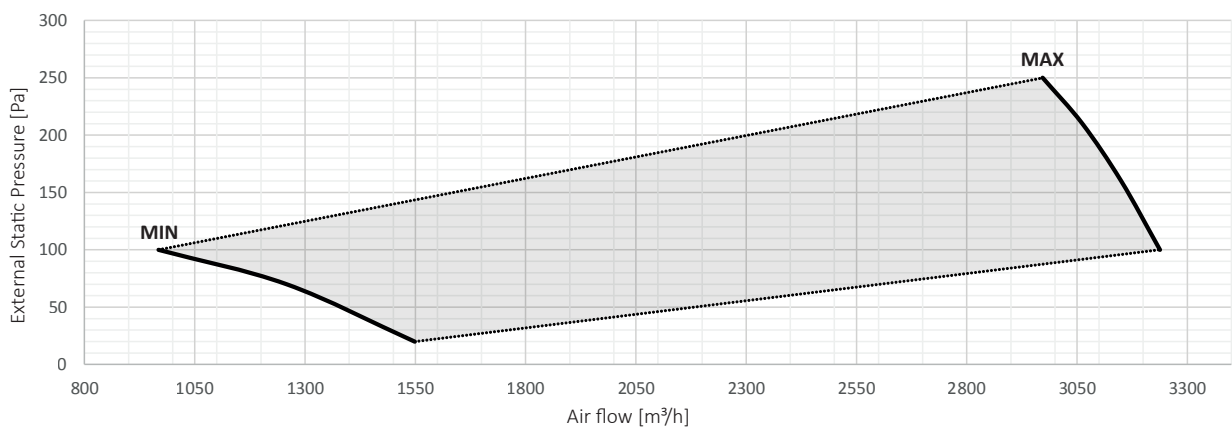

RXV/HE 040

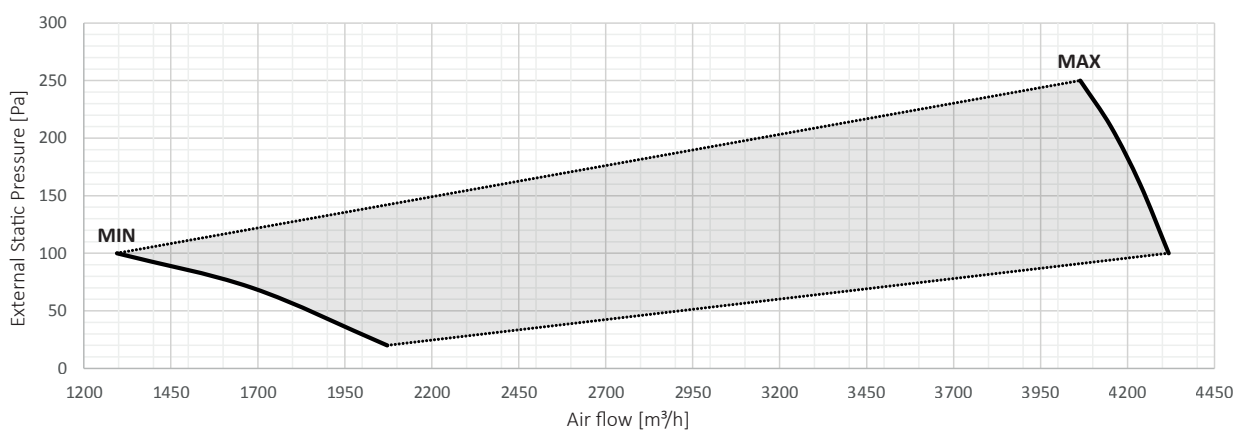

10. OPERATING LIMITS

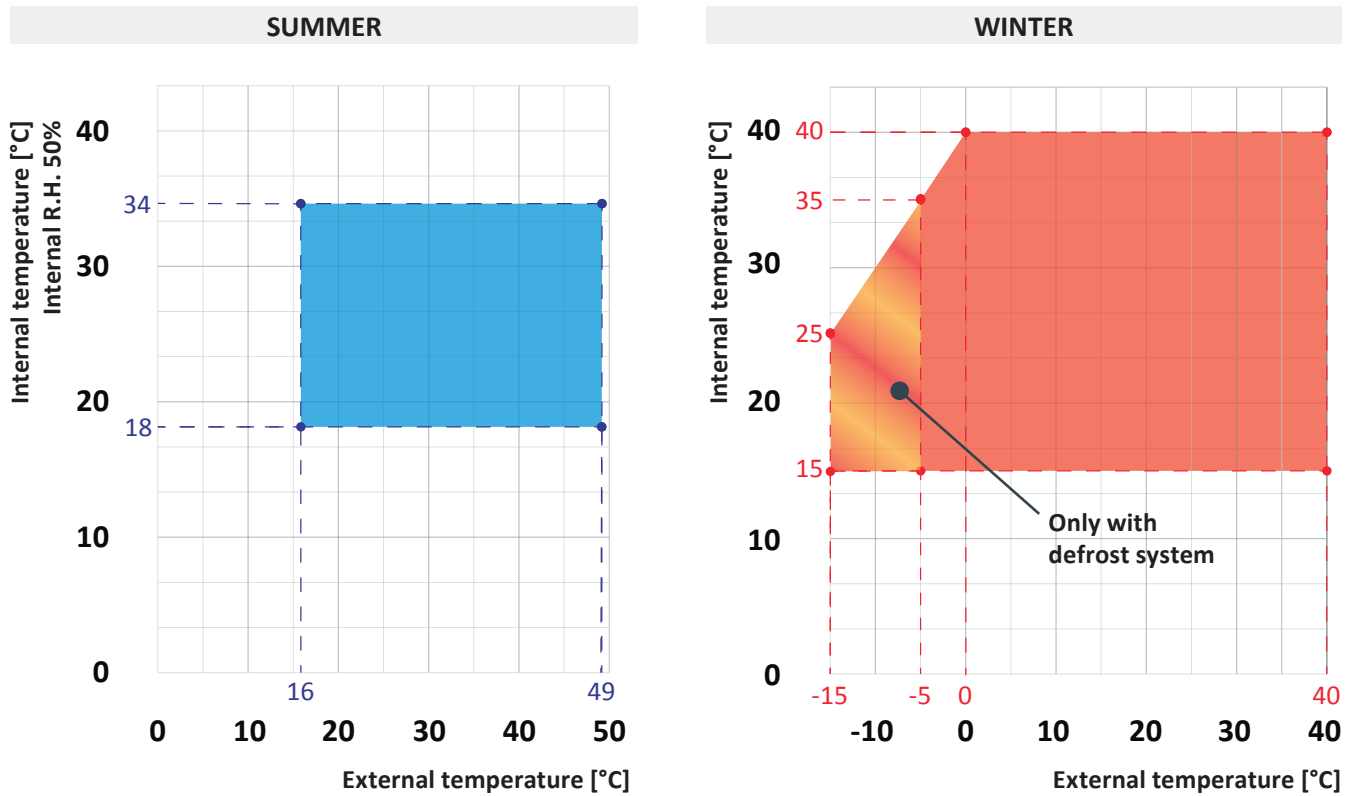

All units can operate, within the given limits, with room relative humidity in the not exceeding 65%.



It is mandatory to use the units within the operating limits shown in the diagrams above. The warranty will immediately expire if the unit is used in working conditions outside the above limits. If it is necessary to operate in conditions outside the operating range of the unit, please contact our technical department.



The units are designed and built to operate with supply water temperatures ranging from 7°C to 80°C.



Units are designed and built to operate inside false technical rooms.
The units are NOT suitable for outdoor installation as condensation may form on the unit's panels and inside the electrical panel with consequent damage to the unit.

11. SOUND DATA

The noise level of units is basically due to the fan rotation speed.

Obviously, with the same air flow rate, the fan speed will be lower if the required static pressure is low, while it will be higher (and therefore noisier) if the required static pressure is higher.

11.1 Noise levels

The table below shows the sound levels of the units at the nominal working conditions:

MOD.	Nominal air flow m ³ /h	E.s.p. Pa	Octave band (Hz)								Lw	Lp
			63	125	250	500	1K	2K	4K	8K	dB(A)	dB(A)
005	410	150	23	35	46	53	57	58	54	51	63	49
006	650	150	34	43	53	61	64	67	63	60	71	57
010	1000	150	30	43	53	61	65	66	61	58	69	54
015	1620	150	39	53	64	68	71	70	66	61	76	60
020	2150	150	59	74	75	78	82	81	73	63	80	64
030	3040	150	45	53	71	74	79	78	74	72	84	67
040	3980	150	71	82	66	69	68	66	61	54	84	67

Lw: sound power level calculated in accordance with EN 3744

Lp: sound pressure level measured in free field at 1 m from the unit, directionality factor Q=2, according to EN 3744 with ducted unit.

11.2 Sound attenuators reduction

The sound attenuators are of the circular absorption type without baffle. They are suitable for reducing the noise that propagates through the ventilation systems in the aeraulic ducts.

MOD.	Nominal air flow m ³ /h	E.s.p. Pa	Octave band (Hz)							
			63	125	250	500	1K	2K	4K	8K
005	410	150	1	3	5	9	14	10	7	8
006	650	150	1	3	5	9	14	10	7	8
010	1000	150	2	4	6	10	14	10	7	8
015	1620	150	2	4	6	10	14	10	7	8
020	2150	150	2	4	6	10	14	10	7	8
030	3040	150	2	4	6	10	14	10	7	8
040	3980	150	2	4	6	10	14	10	7	8

12. SAFETY AND CONTROL DEVICES

- **Supply air temperature probe**

Passive sensor type NTC 10kΩ. Positioned on the supply air side, downstream of the heating/cooling units, it is used to monitor the temperature of the air supplied to the room. It is installed in combination with the temperature control accessories (water coils or post-heating electric resistance). Through this probe it is also possible to control eventual air delivery temperatures in the environment that are too cold in summer or too hot in winter.

- **Return air temperature probe**

Passive sensor type NTC 10kΩ. Positioned on the room air intake and upstream of the filtering section, its purpose is to monitor the temperature of the air extracted from the room to be treated. Always present in all units, it is used as a control probe of the room temperature set and for the management of the summer free-cooling function.

- **Outdoor air temperature probe (fresh air)**

Passive sensor type NTC 10kΩ. Positioned on the fresh air intake and upstream of the filtering section, it is used for monitoring the temperature of the fresh air entering the heat recovery unit. Always present in all units, it is used in combination with the room air intake temperature probe to manage the summer free-cooling function.

- **Exhaust air temperature probe**

Passive sensor type NTC 10kΩ. Positioned on the air outlet and downstream of the plate heat exchanger, it monitors the temperature of the air exhausted from the unit. It is installed in combination with the defrosting kit with the function of controlling the exhaust temperature of the plate heat exchanger in order to avoid freezing of the same during the winter operation of the unit.

- **Electric defrost system**

The defrost system consists of an exhaust air temperature probe and an electrical heater positioned inside the unit on the room return air side, downstream of the filtering section and upstream of the plate heat exchanger. If the temperature downstream of the plate heat exchanger should drop dangerously below the set point and thus avoid the danger of freezing, the electrical heater is activated, which, through a power modulation control (with PWM signal), heats the air extracted from the room and consequently increases the exhaust temperature.

In this way, the ice formation on the exchanger plates is avoided. The power modulation control allows a considerable energy saving thanks to the fact that the electrical energy absorbed by the electric heater is just the one strictly necessary to bring the unit back to optimal working conditions.

- **Unbalanced airflows defrost system**

The defrost system (optional) consists of a specific device and software that avoid an excessive drop of the exhaust air temperature slowing down the supply and return airflow and, in case the opening of the by-pass damper.

This system is normally supplied in combination with the hot water coil (optional).

- **Differential pressure switch**

This component is used to monitor the clogging status of the air filters. There are two pressure switches for each unit, one installed on the fresh air filter section and one located on the room return air filter section. If one of the filters has a pressure difference greater than the recommended limit, an alarm is displayed on the user interface.

- **Differential pressure transducer**

Active type transducer with 4-20mA current output signal. It is installed only in the TOP and PLUS versions and positioned in the electrical panel. In the TOP versions it is connected with the pressure socket available on the supply fan, the purpose is to keep the constant flow rate set by the user.

In the PLUS versions, one pressure tap measures the static pressure at the supply outlet, the other one measures the atmospheric pressure. The aim is keeping the constant supply static pressure. This type of regulation leads to a VAV (Variable air Volume) system that can be used in those applications where a heat recovery unit serves several rooms.

13. INSTALLATION

General warnings and use of symbols



Before carrying out any type of operation, each operator must be perfectly familiar with the operation of the machine and its controls and must have read and understood all the information contained in this manual.



All operations performed on the machine must be carried out by qualified personnel in compliance with the national legislation in force in the country of destination.



Installation and maintenance of the machine must be performed in compliance with applicable national or local legislation.



Do not approach or insert any object into moving parts.

Workers' Health and Safety



The operator's workstation must be kept clean, tidy, and free of objects that may restrict free movement. The workplace should be adequately lightened for the intended operations. Insufficient or excessive lighting may present a hazard.



Ensure that the ventilation of the working areas is always optimal and that the extraction systems are always functional, in good condition and in compliance with the legal requirements.

Personal protection devices



Operators carrying out installation and maintenance of the machine must wear the legally required individual protective equipment listed below.



Safety footwear.



Eye protection.



Protective gloves.



Hearing protection.

13.1 Receipt and inspection

When installing or working on the unit, it is necessary to scrupulously follow the instructions given in this manual, observe the indications on board the unit and in any case apply all necessary precautions. Failure to follow these instructions may result in dangerous situations.

Upon receipt of the unit, check its integrity: the machine left the factory in perfect condition; any damage must be immediately reported to the carrier and noted on the Delivery Note before signing it.

The Company must be informed, within 8 days, about the extent of the damage. The Client must fill out a written report in case of significant damage.

Before accepting the delivery check:

- that the unit has not been damaged during transport;
- that the material delivered corresponds to what is indicated in the transport document.

In case of damages or anomalies:

- immediately note the damage on the Delivery Note;
- inform the supplier, within 8 days of receipt, of the extent of the damage. Reports made after this deadline are not valid;
- in the event of significant damage, file a written report.

13.2 Storage

If it is necessary to store the unit, leave it packed in a closed place. If for some reason the machine has already been unpacked, follow the instructions below to prevent damage, corrosion and/or deterioration:

- make sure all openings are properly plugged or sealed;
- do not use steam or other cleaning agents to clean the unit, as these may damage it;
- remove any keys used to access the control panel and give them to the site manager.

13.3 Unpacking



Packaging material (plastic film, expanded polystyrene, etc.) must be kept out of the reach of children as a potential hazard.

It is advisable to leave the units packed during handling and to remove the packaging only at the time of installation. Remove the packaging of the unit with care to avoid possible damage to the machine.

The materials making up the packaging can be of different kinds (wood, cardboard, nylon, etc.). It is advisable to remove the protective film from the panels (if present) after the installation of the unit.



Packaging materials should be stored separately and handed over for disposal or recycling to the appropriate.

13.4 Lifting and Handling

When unloading and positioning the unit, care must be taken to avoid sudden or violent manoeuvres to protect internal components.

Lifting should be done using a forklift or alternatively using straps, taking care not to damage the side and top panels of the unit.

The length of the forks must be adequate for the length of the section to be handled in order to avoid the risk of tipping over and/or damaging the bottom of the unit.

During handling and transport, sections must remain in position as packed at the factory, and absolutely no tipping or tilting should be done.

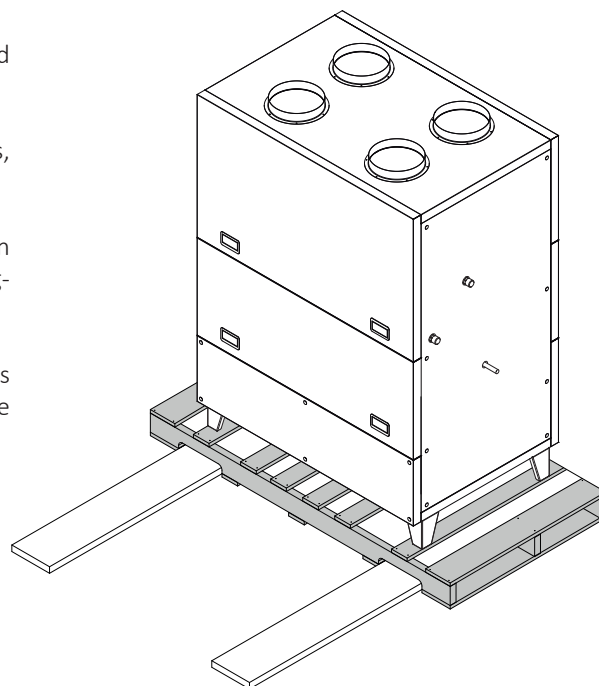

13.5 Positioning and minimum technical spaces

The drawing below shows the installation of the unit, where the minimum measures must be observed in order to guarantee the extraction and subsequent cleaning of the air filters, maintenance and control of the electrical panel.

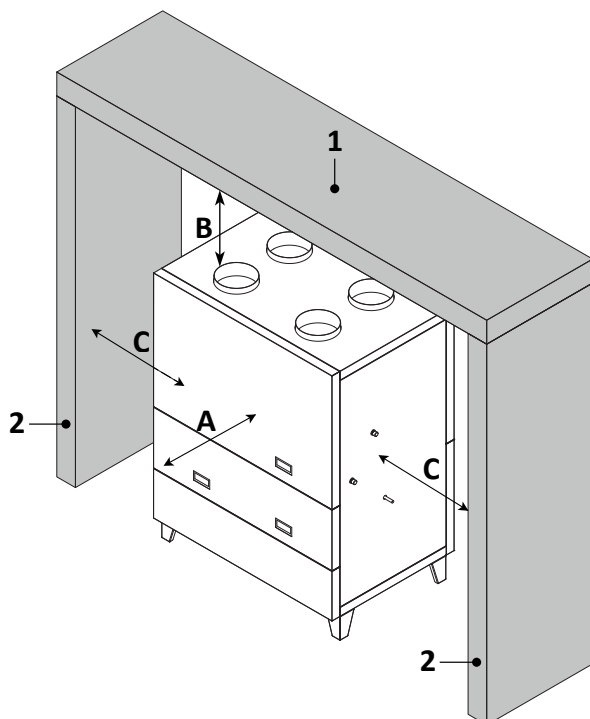

MOD.	A	B	C
005	600	500	500
006	600	500	500
010	600	500	500
015	600	500	500
020	600	500	500
030	600	500	500
040	600	500	500

CAPTION:

1. Ceiling | 2. Side walls



Install the unit to allow ordinary and extraordinary maintenance. The warranty does not cover costs related to platforms or handling equipment necessary for any intervention.



Choose the installation site in accordance with EN 378-1 and 378-3.

13.6 Connecting additional sections: Sound attenuators

The sound attenuators are fastened with the screws provided between the edge at the end of the sound attenuator and the circular connection of the unit.

The other end will be fixed, again with the supplied screws, to the circular duct.

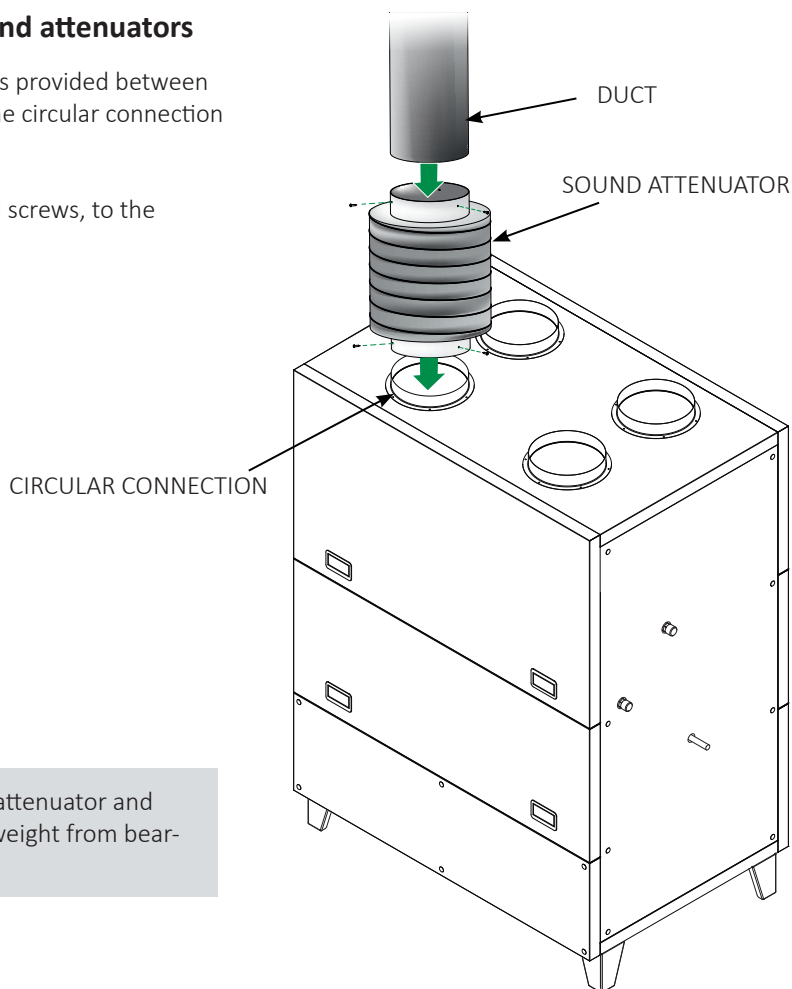

Provide brackets to hold the sound attenuator and ductwork in order to prevent their weight from bearing on the unit.

13.7 Condensate drain connection

The connection to the condensate drain must be carried out on site by the customer, through a rigid pipe attached to the 1/2" F external diameter fitting located on the bottom panel of the unit. A siphon sized for the maximum vacuum inside the unit must be installed on the condensate drain pipe.

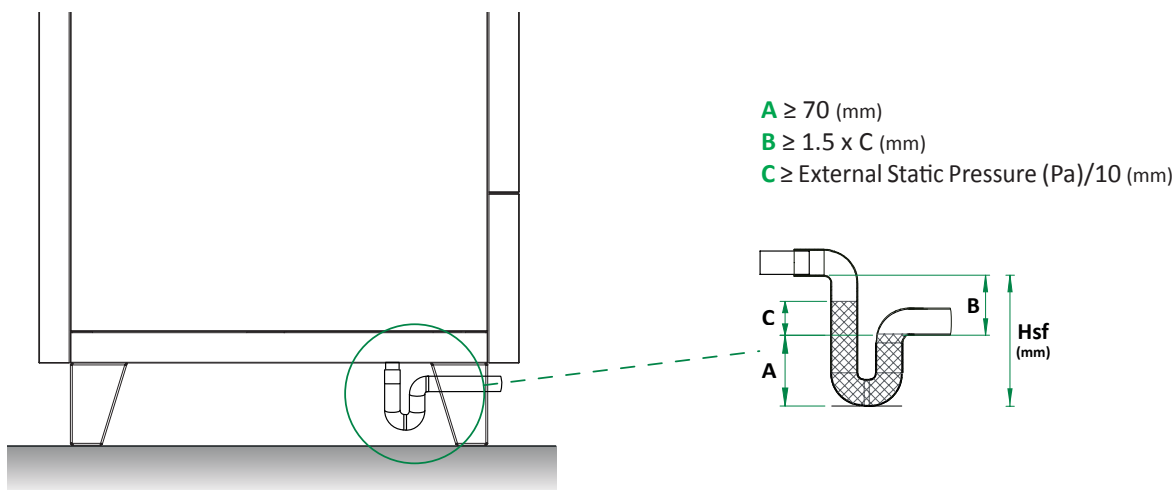

- Each drain must be independent and have its own siphon.
- The lack of a siphon may affect the proper operation of the unit.
- It is necessary to trigger the siphon by pouring water into it before starting the unit.

13.8 Hydraulic connection to the water coil

For a correct hydraulic connection to the water coil and to the relative modulating 3-way valve, proceed as shown in the diagram below:

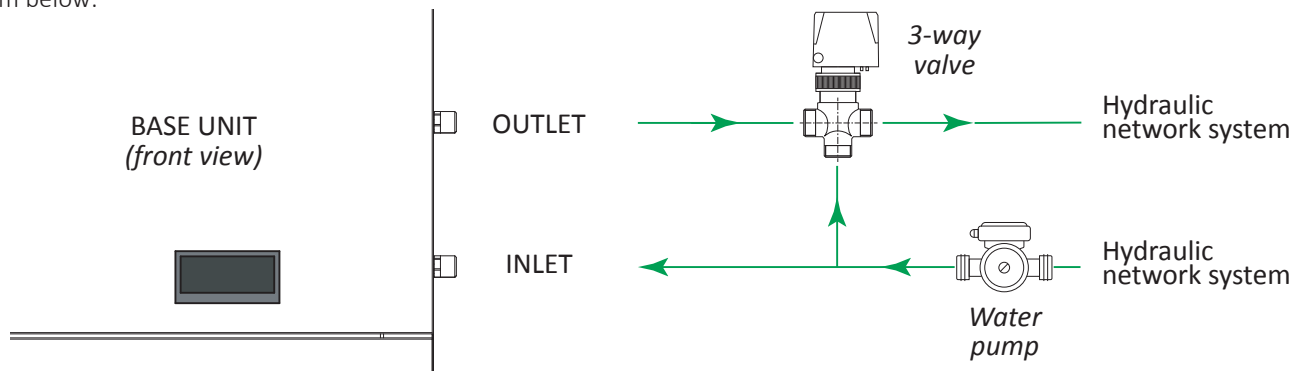

GENERAL RULES

- Respect the IN/OUT adhesive references on the side of the unit;
- The path of the pipes must be assessed so as not to create particular obstacles in case of removal of the coil;
- The piping must be supported by specific brackets in order to prevent their weight from bearing on the unit;
- The interposition of flexible joints is strongly recommended in order to avoid the transmission of vibrations and noise;
- During installation the hydraulic connections of the coil must be protected from twisting by locking;
- For proper operation of the equipment, it is recommended to supply the unit with a dedicated pump and to vent the circuit using the appropriate vent valves on the coil manifold.

13.9 How to vent the unit

For a proper functioning of the system, it is essential to remove the air from the hydraulic circuit.

To vent the coil, proceed as follows:

- unscrew the fastening screws of the frontal upper panel;
- remove the panel using the dedicated handles;
- use the vent valve located on the internal manifold of the coil.

After venting the unit, close the panel with the screws.

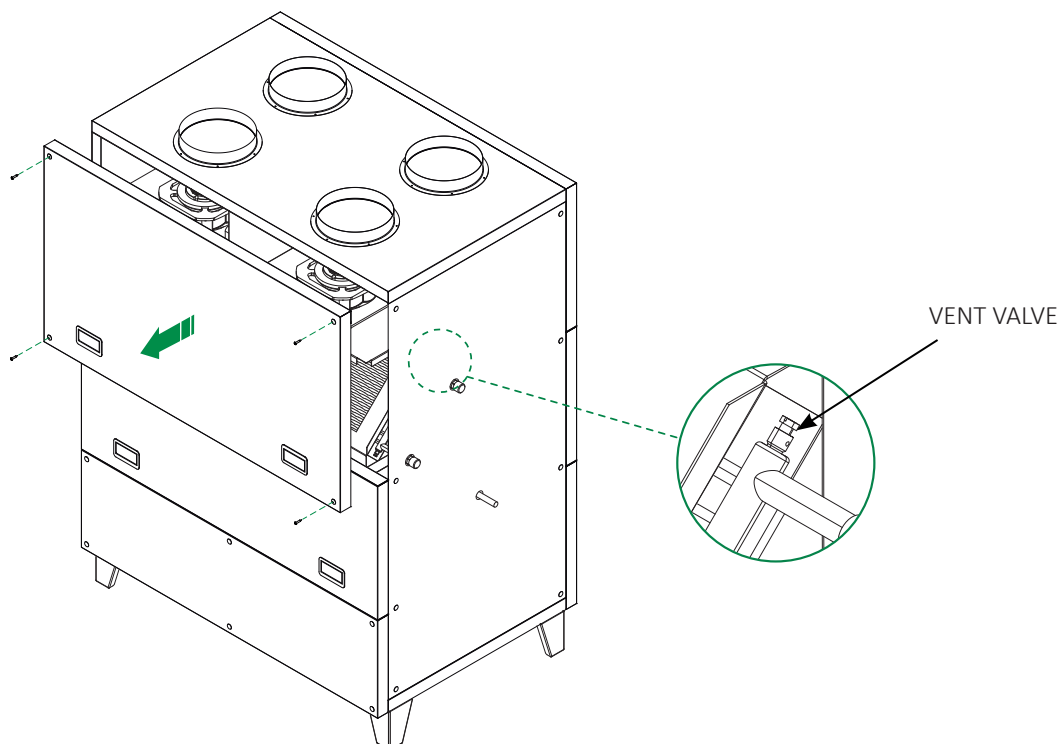

13.10 Connecting the unit to air ducts

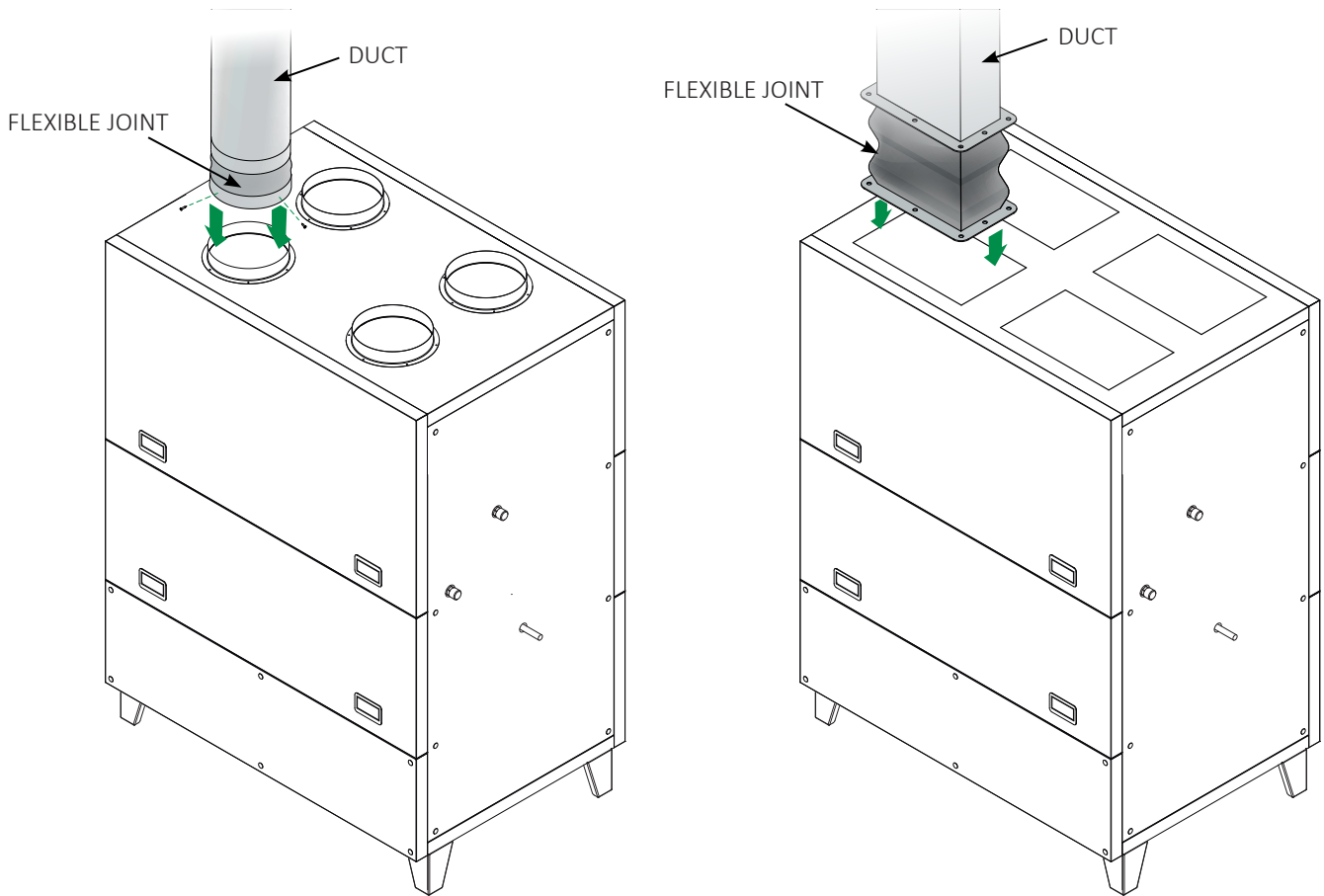

GENERAL RULES

For a correct installation of the ductwork it is recommended to:

- design the duct so that the air speed never exceeds 4-5 m/s, for the purpose of noise containment;
- provide suitable brackets to support the ducting to prevent their weight from bearing on the unit;
- always use a flexible joint between the unit and the ductwork;
- provide an electrical earth cable to bridge the flexible joint, to ensure the duct and the unit are electrically equipotential;
- before bends and branches, provide a straight duct with a length equal to at least 2.5 times the shorter side or the diameter of the duct to avoid drops in fan performance.

13.11 FILTERS and HEAT EXCHANGER access

To inspect the filters, loosen the screws on the top front panel and remove it using the handles provided. Then take off the removable panels with bridge handles, located behind the fans and proceed with the extraction of the filters, as shown in the illustration below.

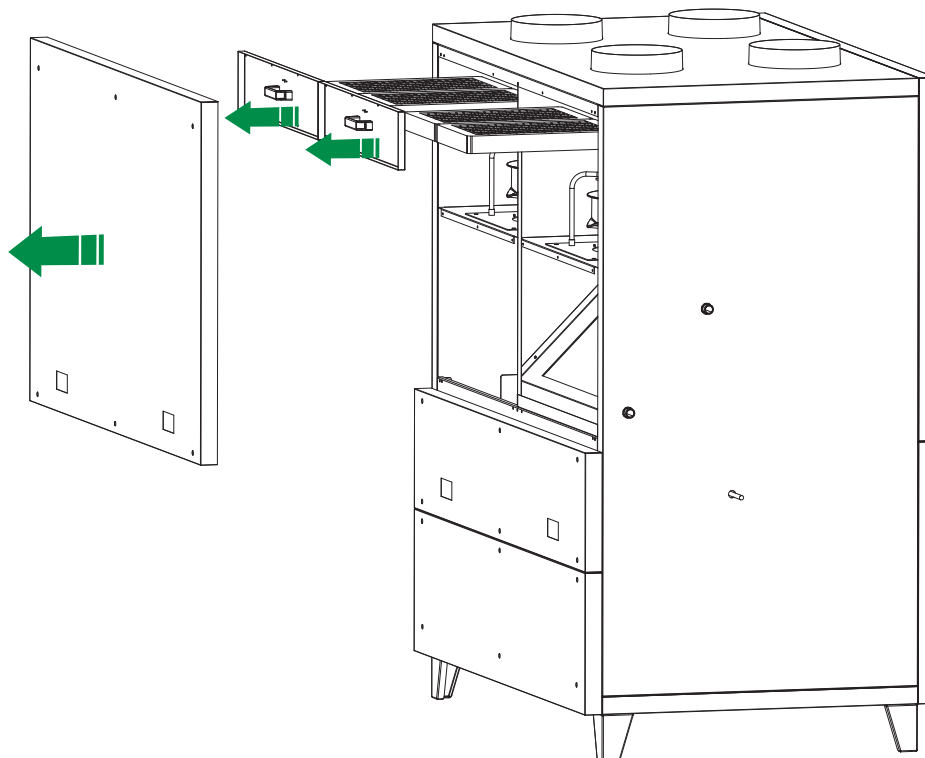

The heat exchanger is not fully removable for this product range, but it can be inspected through the front/rear lower panels of the unit.



Do not use water to clean the heat exchanger, but it is possible to vacuum the exchanger pack.

14. RS485 SERIAL INTERFACE CARD

Serial line interface card to the supervision system (available only MODBUS-RS485). The installation of the card will allow the unit to be connected to a system with MODBUS-RS485 protocol.

This system allows you to remotely monitor all the operating parameters of the unit and change their values. The serial interface card is installed and wired exclusively in the factory.

The unit does not work in case of inversion of the polarity of the wiring. The unit is programmed with serial address 1. The list of MODBUS variables is available by contacting the company.

15. CO2 PROBE

The CO2 air quality probe can only be available for ECO configuration units. It is installed inside the unit, on the return room intake and wired at the factory. The probe measures the carbon dioxide amount present in the room, according to the value it will increase (or decrease) the fresh air volume so that the presence of CO2 will be diluted.

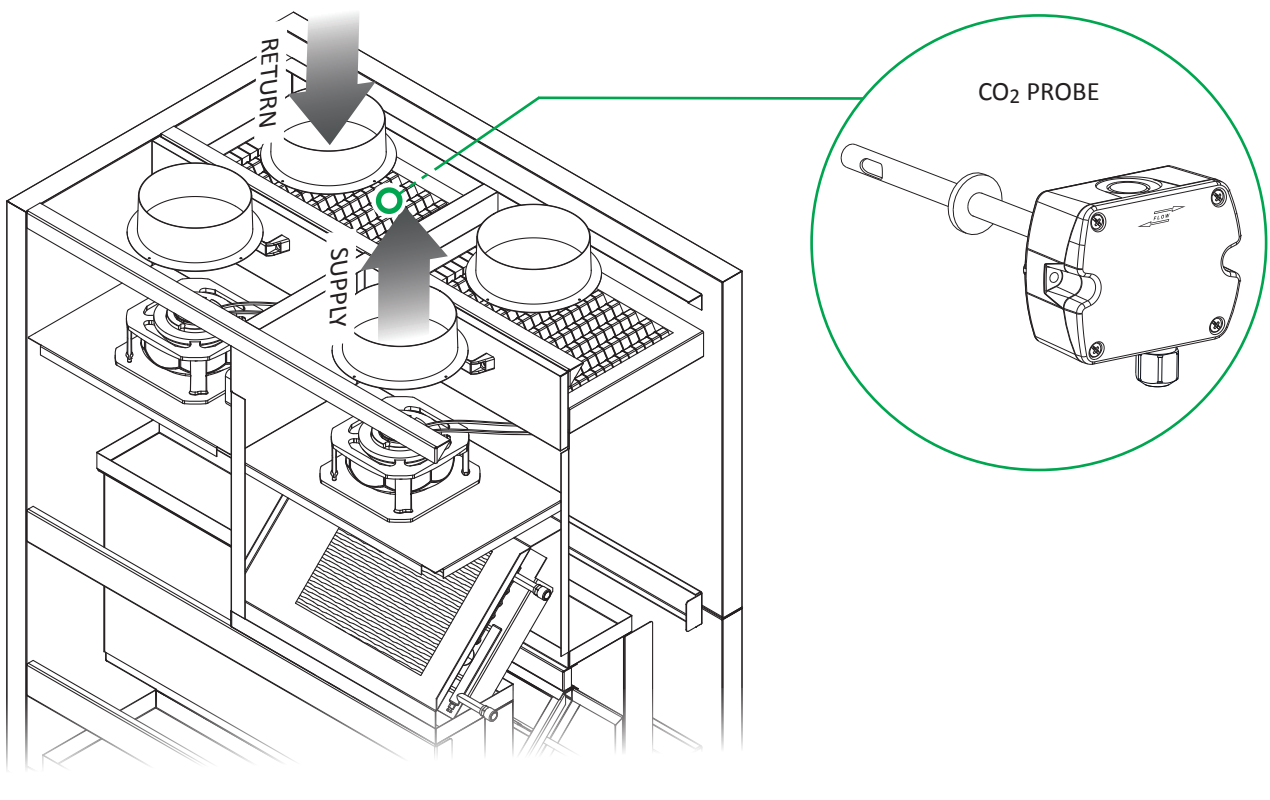

TECHNICAL DATA

Measuring range	ppm	0-2000
Grade of accuracy at 25°C	%	± 5
Interval of measure	sec.	about 15
Temperature operating range	°C	20 - 60
Humidity operating range	%	0 - 95

16. ELECTRICAL CONNECTIONS

Preliminary safety information



The electrical connection must be made according to the wiring diagram enclosed with the unit and in compliance with local and international regulations.



Make sure the disconnector of the unit power supply line is upstream the unit. Ensure it is padlocked or that the appropriate warning is present indicating not to operate.



Check that the power supply corresponds to the rated data of the unit (voltage, phases, frequency) shown on the wiring diagram and on the nameplate attached to the unit.



Power supply cables must be protected upstream against electric short-circuit and overload by a suitable device complying with current standards and laws.



The cross-section of the cables must be suitable for the calibration of the upstream protection system and must take into account all factors that may affect it (temperature, type of insulation, length, etc.)



The warranty will be void if the power supply does not comply with the above limits.



Make all earthing connections required by current standards and legislation.



Make sure to disconnect the power supply before beginning any operation.



FROST PROTECTION:
when open, the main switch excludes the electric power to the heating elements and any antifreeze device in the unit. Open the main switch only for cleaning, maintenance or repair of the unit.

16.1 Electrical data



The following electrical data refer to the basic unit without accessories.
In all other cases, refer to the electrical data in the wiring diagram attached to the unit.



The supply voltage must not vary more than $\pm 10\%$ of the nominal value and the unbalance between phases must be less than 1% according to EN 60204.
Please contact our technical department in case these tolerances are not respected.

MODEL		005	006	010	015	020	030	040
Power supply	V/Ph/Hz	230/1/50	230/1/50	230/1/50	230/1/50	230/1/50	400/3+N/50	400/3+N/50
Control circuit		12 VDC / 24 VAC						



Electrical data may change without notice. Therefore, ALWAYS refer to the wiring diagram supplied with the unit.

16.2 Power supply connection

Remove the front panel of the electrical cabinet with the appropriate tool; use the cable gland on the side panel and connect the power supply cable inside the electrical cabinet to the disconnecting switch with fuses. After making the connection, carefully close the front panel of the electrical cabinet.

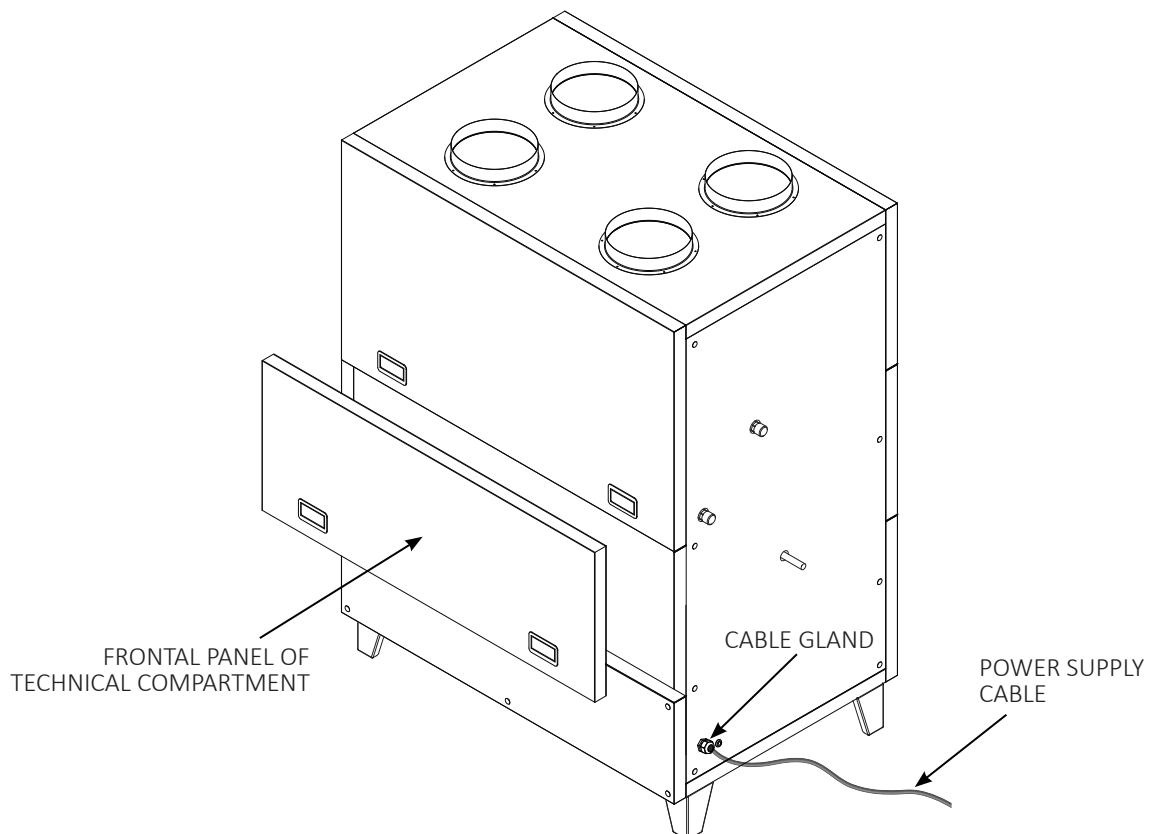

16.3 Terminal Block Connections



Terminal numbers may change without notice. ALWAYS refer to the wiring diagram supplied with the unit.

All the terminals shown in the following tables are in the terminal block inside the electrical cabinet, all the electrical connections mentioned below must be made in the field by the installer.

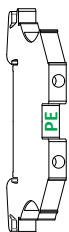

SINGLE-PHASE POWER SUPPLY

It is used to power supply the unit with single-phase system (mod. 005 - 006 - 010- 015- 020).

The power cable should be connected directly to the fuses or to the electric coil mainswitch. The earth terminal is present (PE).

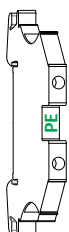

THREE-PHASE POWER SUPPLY

It is used to power supply the unit with three-phase system (mod. 030 - 040).

The power cable should be connected directly to the fuses or to the electric coil mainswitch. The earth terminal is present (PE).

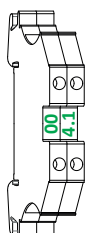

REMOTE ON/OFF

It is used to turn on/off the unit from a remote device.

The units are supplied as standard from the factory with jumpered terminals.

Closed contact: unit is **ON**;

Open contact: unit is **OFF**.

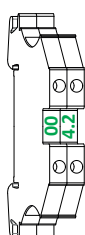

FIRE/SMOKE ALARM

It is used to turn off the unit from an external fire control unit.

The units are supplied as standard from the factory with jumpered terminals.

Closed contact: no unit alarm works;

Open contact: alarm from external fire control unit. The unit stops.

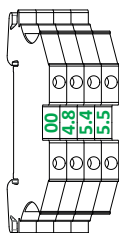

REMOTE DISPLAY FOR CONTROL

D2 - EPJ Graph

00 connect to terminal **VAC-** of the display;

4.8 connect to terminal **VAC+** of the display;

5.4 connect to terminal **CAN+** of the display;

5.5 connect to terminal **CAN-** of the display;

The remote display is only suitable for indoor use, it cannot be installed in areas with strong vibrations, aggressive/corrosive agents, very dirty or high humidity.

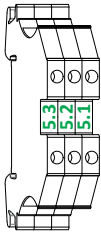

MODBUS RS-485 CONNECTION

5.3 connect the negative pole (-) of the ModBus network;
 5.2 connect the positive pole (+) of the ModBus network;
 5.1 connect the GND of the ModBus network;
 allows connection to a supervisory system (BMS) via ModBus RTU communication protocol on RS-485 serial line

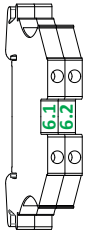

PUMP CONTROL (water coil) or CONDENSING UNIT (direct expansion coil)

Control by voltage-free contact, which sends a consent to the external water pump, (if water coil is present) or to the condensing unit (if direct expansion coil is present):

accessory A: cold water coil;
 accessory B: hot water coil;
 accessory E: direct expansion coil.

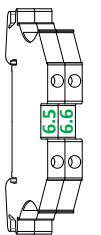

REMOTE GENERAL ALARM

For remote signalling of a general alarm.
 Voltage-free contact.

Contacts 6.5 / 6.6 NO (Normally Open)

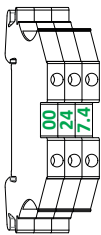

3-WAY VALVE ACTUATOR (HEATING COIL)

00 e 24 power supply of the valve actuator;
 7.4 0-10V control signal from PLC card;

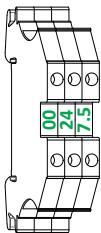

3-WAY VALVE ACTUATOR (COOLING COIL)

00 and 24 power supply of the valve actuator;
 7.5 0-10V control signal from PLC card;

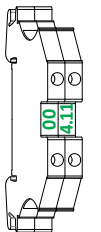

DIRECT EXPANSION COIL

00 and 4.11 0-10V control signal from PLC card;

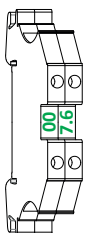

ALARM FROM CONDENSING UNIT

00 e 7.6 alarm signal from external condensing unit;

16.4 Detail of electrical panel

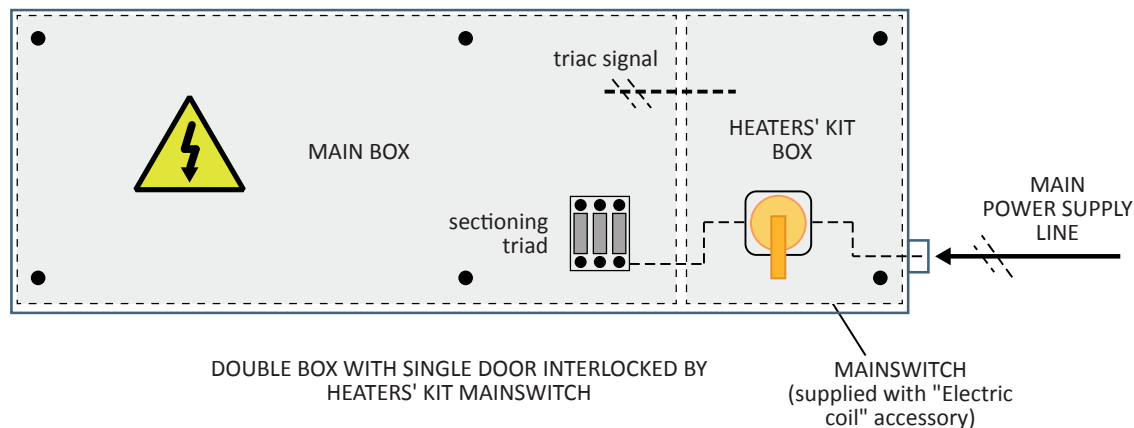

17. STARTUP

17.1 Preliminary checks

It is necessary to carry out preliminary checks on the electrical and hydraulic parts before starting the unit.



Perform the commissioning operations in accordance with all the requirements of the previous paragraphs.



Malfunctions or damage may also result from lack of proper care during shipment and installation. It is good practice to check before installation or commissioning that there are no damages due to tampering, vibration during transport, mistreatment suffered on site.

- Check that the machine is installed in a state of the art manner and in accordance with the instructions in this manual.
- Check electrical connection and correct fastening of all terminals.
- Check that the voltage is as indicated on the unit's rating plate.
- Check that the unit is connected to the earth system.
- Check that there are no leakages.
- Check that the hydraulic connections have been installed correctly and that all indications on the nameplate are respected.
- Check that the system has been properly vented.
- Check that fluid temperatures are within operating limits.
- Before turning the unit on, check that all closing panels are in place and secured with the appropriate screws.







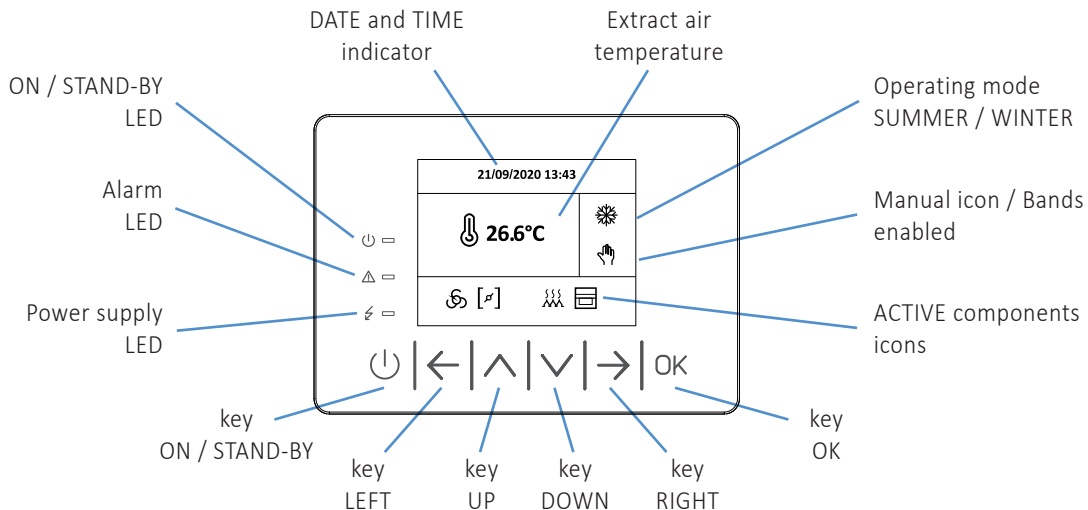

Do not modify the internal electrical connections as this will immediately invalidate the warranty.

17.2 Description of the controller

FUNCTION OF KEYS AND DISPLAY ICONS



KEY	FUNCTION
	<ul style="list-style-type: none"> • press and hold will turn on or turn off the device • press and hold will reset the alarms with manual reset • while setting the parameters, it has the function of “Back” key • a simple pressure from main screen allows the access to the alarm page
	<ul style="list-style-type: none"> • a simple pressure allows to move within the status pages
	<ul style="list-style-type: none"> • a simple pressure allows to move on a superior menu during the menu navigation • a simple pressure allows to increase one unit the value of the variable. Specific variable edit mode should be activated
	<ul style="list-style-type: none"> • a simple pressure allows to move on an inferior menu during the menu navigation • a simple pressure allows to decrease one unit the value of the variable. Specific variable edit mode should be activated
	<ul style="list-style-type: none"> • a simple pressure allows to move within the status pages
	<ul style="list-style-type: none"> • press and hold allows to enter and exit the settings menu • a simple pressure allows to change the parameter value and set-point and confirm it while it is set to “edit” (blinking) • during the menu navigation, it has the function of “Enter” key

18. UNIT USE

18.1 Turn ON the unit and setting parameters

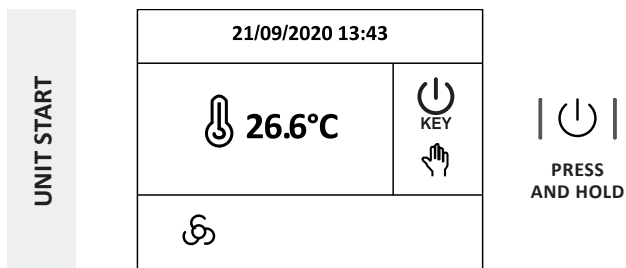

Once the unit is powered and the main-switch is activated, the display turns ON and shows a screen similar to the one you can see above, i.e. unit turned off by KEY. From this screen, it is necessary to press and hold the "ON/STAND-BY" key in order to activate the unit.

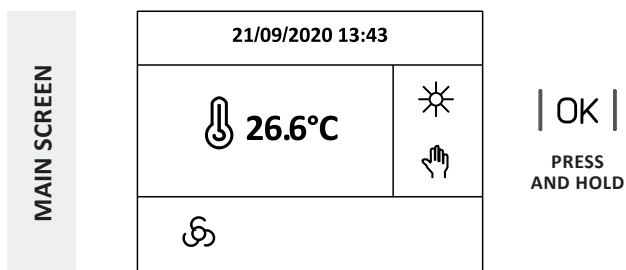

When the unit starts, from this screen it is possible to access to all the menu following explained, through press and hold of the "OK" key.

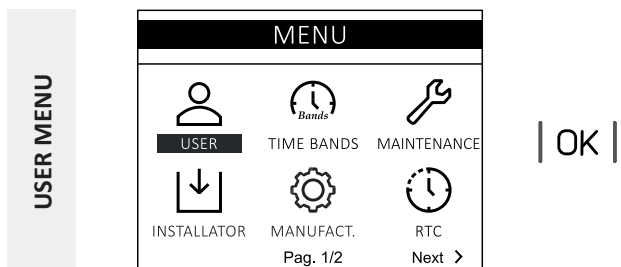

Access to the USER menu does not require a password. In this menu there are all the parameters that the user can freely modify. Press the "OK" key to access.

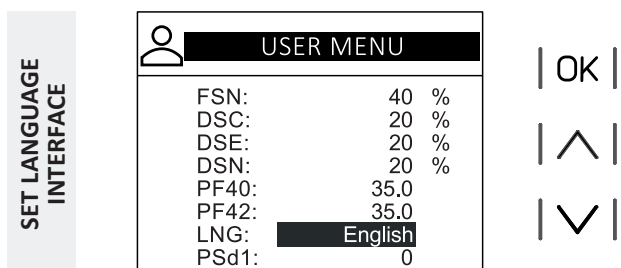

Using the "UP" or "DOWN" keys, navigate to the LNG parameter and select the value "English" or another language. Confirm the value entered with the "OK" key.

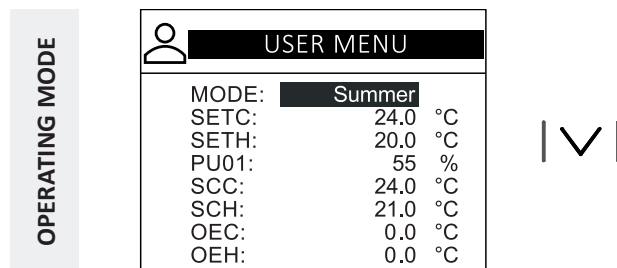

To change the operation mode, use the "UP" or "DOWN" keys and navigate to the MODE parameter. Select the desired value according to the required operation mode of the unit.

Summer = COOLING MODE | **Winter** = HEATING MODE

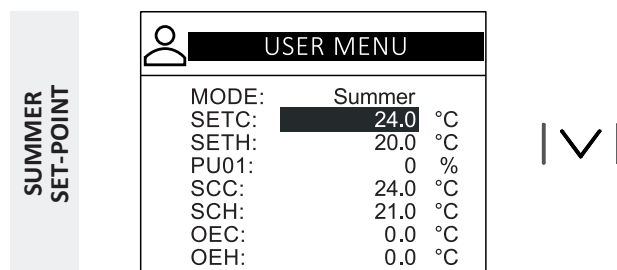

To change the summer set-point:

- press the "OK" key, the value blinks;
- press the "UP" or "DOWN" keys to change the parameter;
- confirm with "OK" key.

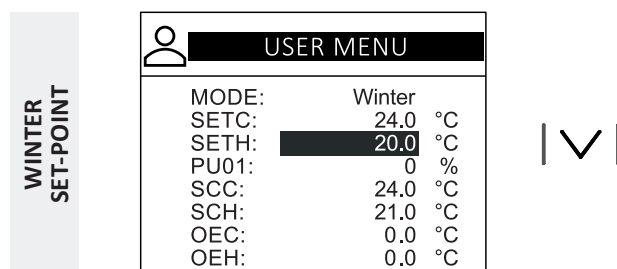

To change the winter set-point:

- press the "OK" key, the value blinks;
- press the "UP" or "DOWN" keys to change the parameter;
- confirm with "OK" key.

CONSTANT FLOW AND PRESSURE SETTING

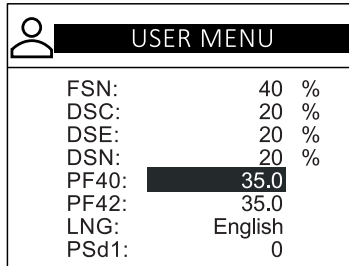

[PLUS Vers.] SET-POINT CONSTANT PRESSURE (Pa x10)
 [TOP Vers.] SET-POINT CONSTANT FLOW RATE (m³/min)

Parameter PF40 relates to supply air, while PF42 is the parameter relating to return air.

To change the parameter:

- press the "OK" key, the value blinks;
- press the "UP" or "DOWN" keys to change the parameter;
- confirm with "OK" key.

AIR-FLOW SETTING [ECO VERSION]

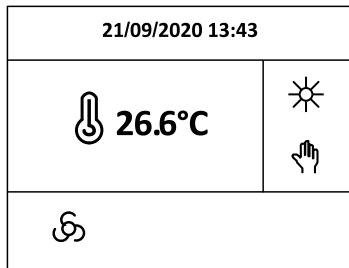

[ECO Vers.] SETTING AIR-FLOW RATE

From the main screen:

- press the "UP" or "DOWN" keys to increase/decrease the rotation speed of the fans.

USER MENU PASSWORD

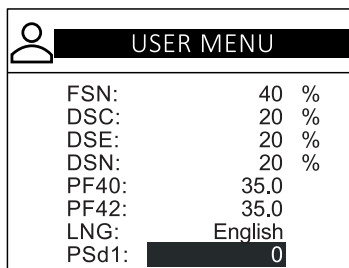

USER MENU **PASSWORD**

(0 = PSW not required for the access)

To change the parameter:

- press the "OK" key, the value blinks;
- press the "UP" or "DOWN" keys to change the parameter;
- confirm with the "OK" key.

18.2 Set "Real Time Clock" (RTC)

CLOCK SETTINGS

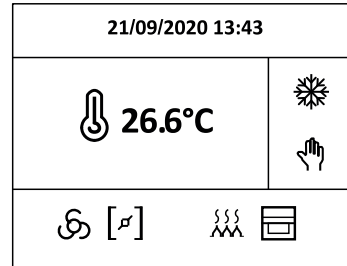

In the event of a prolonged power failure, it may be necessary to reset the unit's RTC clock ("ALARM 29").

From the main screen, through press and hold of the "OK" key, the USER MENU is accessible.

RTC MENU

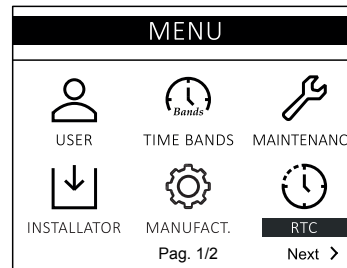

Then select the RTC icon and press the "OK" key to access.

DATE / TIME



To change the date and time:

- press the "OK" key, the value blinks;
- press the "UP" or "DOWN" keys to change the parameter;
- press the "LEFT" or "RIGHT" keys to move from one parameter to another;

Once the setting is complete, press the "OK" key to confirm the entered values. Press the "ON/STAND-BY" key twice to return to the main screen.

18.3 Set operation by time bands

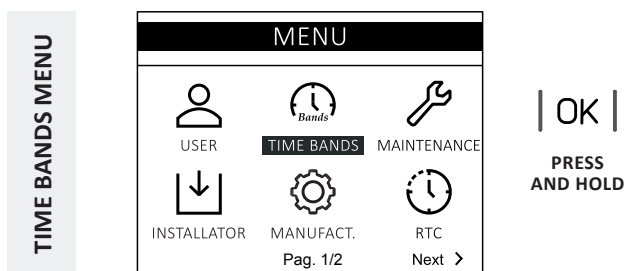

With the unit in operation / switched off, press and hold the "OK" key to access to the user menu screen.

Then select the *TIME BANDS* icon and press the "OK" key to access.

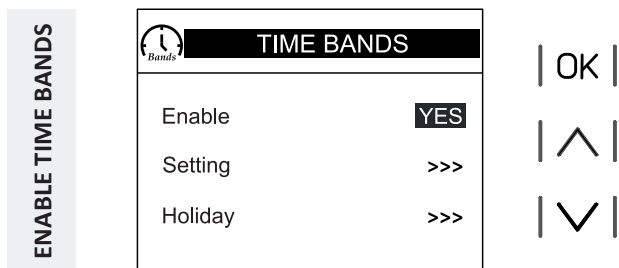

The cursor is positioned on the item *Enable*:

- press the "OK" key, the value blinks;
- press the "UP" key to enable the time bands;

To set the time bands, go to *Setting*:

- press the "OK" key to access to the setting menu for the day MONDAY.

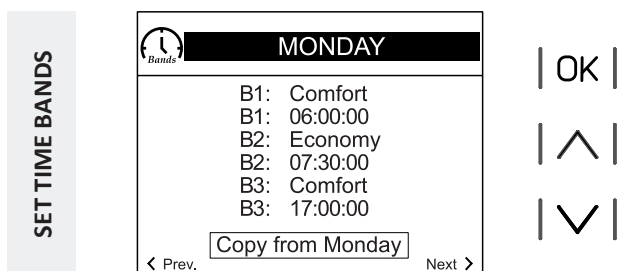

To set values in *B1, B2, B3, B4* bands:

- press the "OK" key, the value blinks;
 - press the "UP" or "DOWN" keys to change the parameter;
- The available options are: "Off" "Comfort" "Economy" "Night".
- confirm the parameters with the "OK" key.

To change the start times of the *B1, B2, B3, B4* bands:

- press the "OK" key, the value blinks;
- press the "UP" or "DOWN" keys to change the parameter;
- press the "LEFT" or "RIGHT" keys to move from one parameter to another;
- confirm the parameters with the "OK" key.

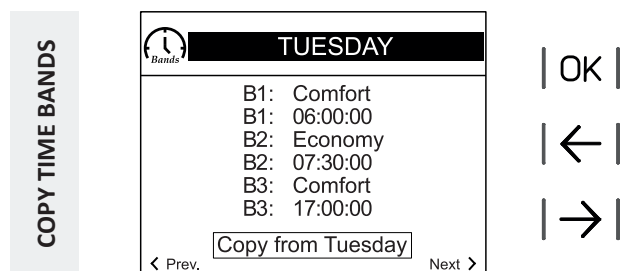

To change to a previous / next day:

- press the "LEFT" or "RIGHT" keys to change the day;

To set time bands on all other days, follow the same procedure as described before.

To copy time bands from one day to another, use the "Copy from ..." button.

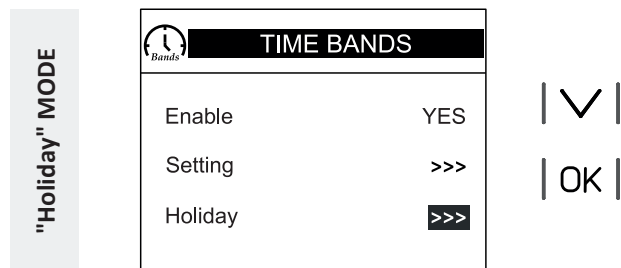

It is possible to set *Unit ON/Unit OFF* mode for a period of absence. This mode is activated from the moment of setting.

From the *TIME BANDS* menu, select the *Holiday* item using the "DOWN" key and confirm with the "OK" key.

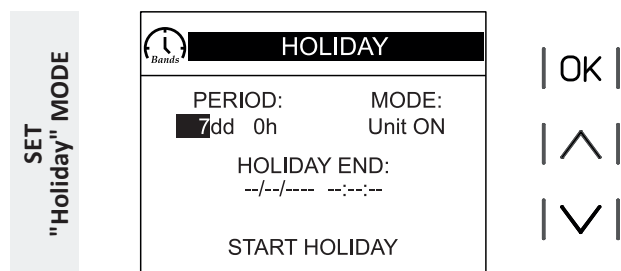

To set the *Holiday* mode:

- press the "OK" key, the value of days/hours blinks;
- press the "UP" or "DOWN" keys to change the parameter;
- confirm with the "OK" key.

To set the *Unit ON/OFF* mode, follow the same procedure as described before.

In the *HOLIDAY END* field, set the day and time when the programmed holiday period ends.

Selecting the *START HOLIDAY* field and pressing the "OK" button the holiday mode start immediately.

To deactivate this mode, set the *PERIOD* values to 0 and confirm with the "OK" key on *START HOLIDAY*.

18.4 Enable control with CO₂ air quality sensor (ECO version only)

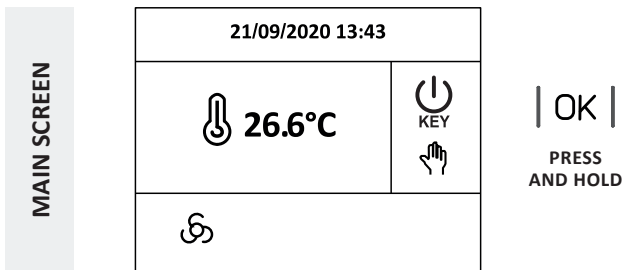

If the unit is ON, switch it OFF. Connect the CO₂ sensor as shown in the circuit diagram. From the main screen, through press and hold of the "OK" key, the MENU is accessible.

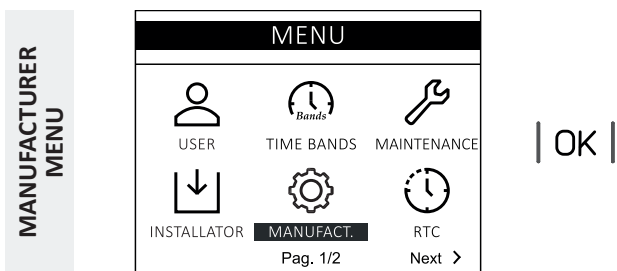

Select the MANUFACTURER icon and press the "OK" key to access.

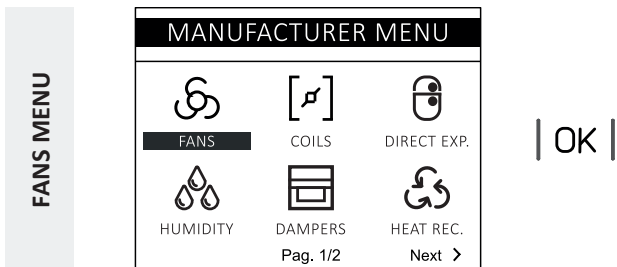

Then select the FANS icon and press the "OK" key to access.

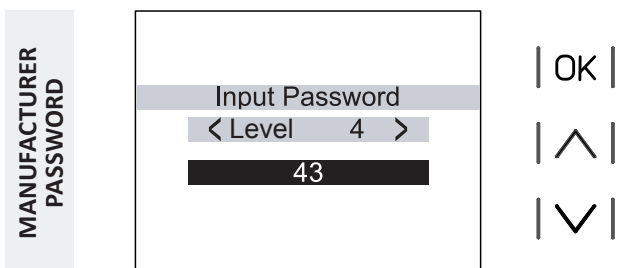

MANUFACTURER MENU PASSWORD = 43

To change the parameter:

- press the "OK" key, the value blinks;
- press the "UP" or "DOWN" keys to change the parameter;
- confirm with the "OK" key.

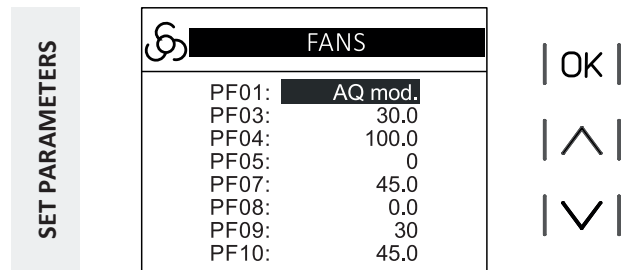

Using the "UP" or "DOWN" keys, navigate to the PF01 parameter and select the value "AQ mod." Confirm the value entered with the "OK" key.

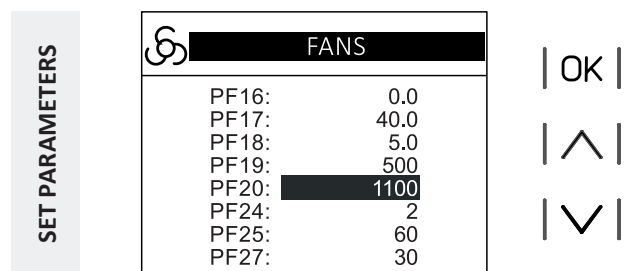

The air flow rate depending on the level of CO₂ in the room. The parameters PF19 and PF20 set the min/max PPM limits. Default values are 500/1100 ppm, within which the ventilation varies from min flow rate of 30% to max flow rate of 100%.

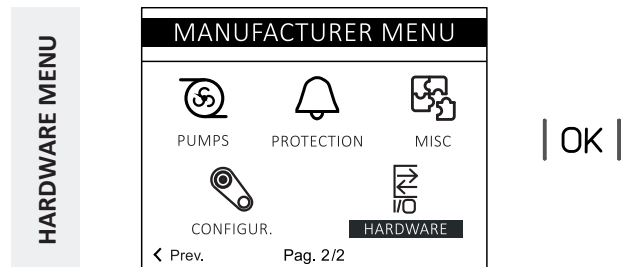

From the MANUFACTURER menu, select the HARDWARE icon and press the "OK" key to access.

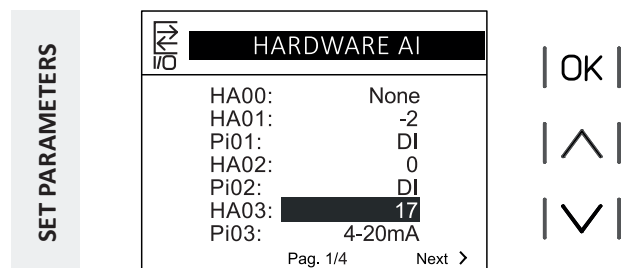

If required, enter the MANUFACTURER PASSWORD = 43

Using the "UP" or "DOWN" keys, navigate to parameter HA03, select the value "17" and confirm with the "OK" key. Press the "ON/STAND-BY" key several times to return to the main screen and then restart the unit.

18.5 Enabling reversible mode of the cooling coil

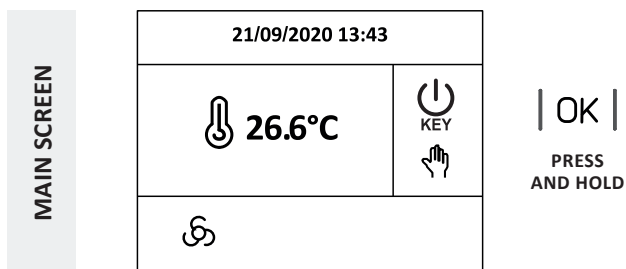

If the unit is ON, switch it OFF. From the main screen, through press and hold of the "OK" key, the MENU is accessible.

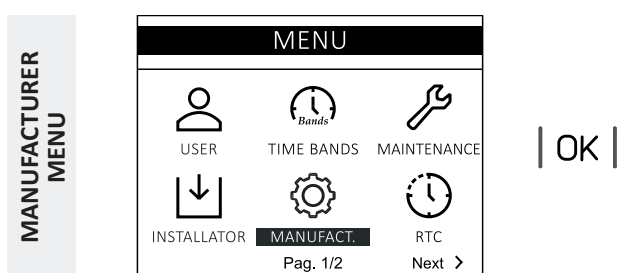

Select the MANUFACTURER icon and press the "OK" key to access.

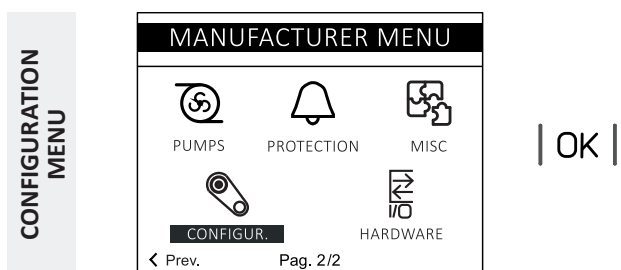

Then select the CONFIGURATION icon and press the "OK" key to access.

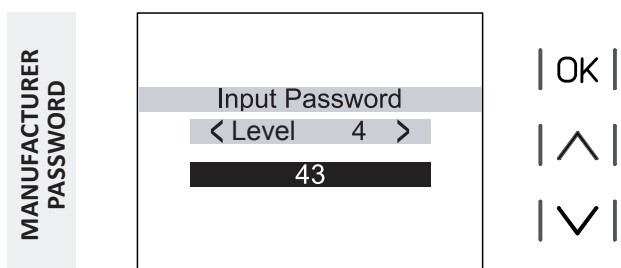

MANUFACTURER MENU PASSWORD = 43

To change the parameter:

- press the "OK" key, the value blinks;
- press the "UP" or "DOWN" keys to change the parameter;
- confirm with the "OK" key.

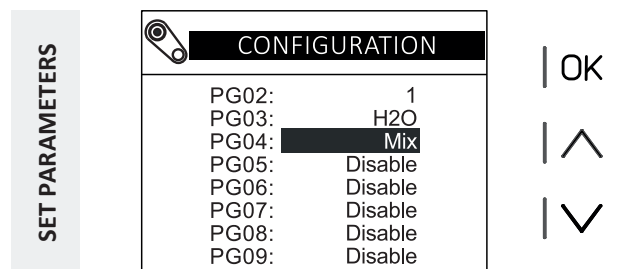

Using the "UP" or "DOWN" keys, navigate to the PG04 parameter and select the value "Mix".

Confirm the value entered with the "OK" key.

Press the "ON/STAND-BY" key several times to return to the main screen.

CAUTION !!!

This procedure is valid ONLY to enable heating operation of a cooling coil and NOT VICEVERSA.

The company accepts no responsibility if the user enables cooling operation of a heating coil, as this does not have a condensate drain pan, which would cause water to be present inside the unit.

18.6 Alarms display and reset

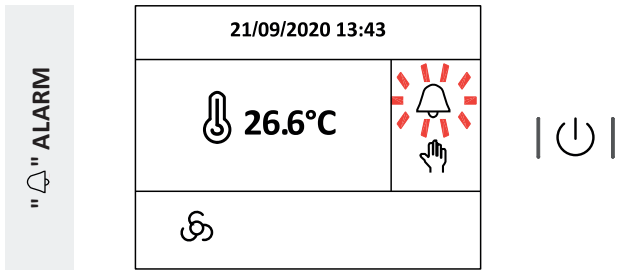

When an alarm is triggered requiring the immediate **STOP** of the unit, the unit automatically turn OFF, the blinking "BELL" icon appear on the screen, and the corresponding LED blinks on the left side of the controller.

From the main screen, press the "ON / STAND-BY" key (simple pressure) to have access to the ALARM PAGE.

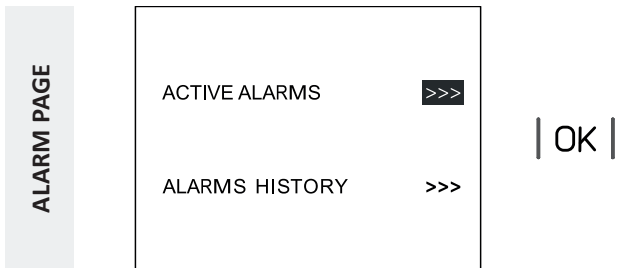

Pressing the "OK" key alarms will be displayed.

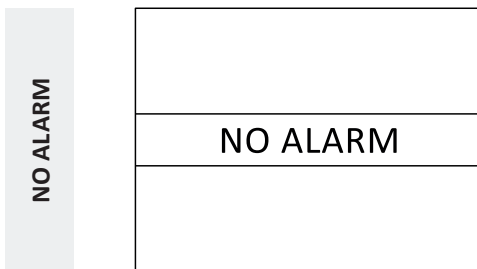

If there are no alarms, the "NO ALARM" screen is displayed.

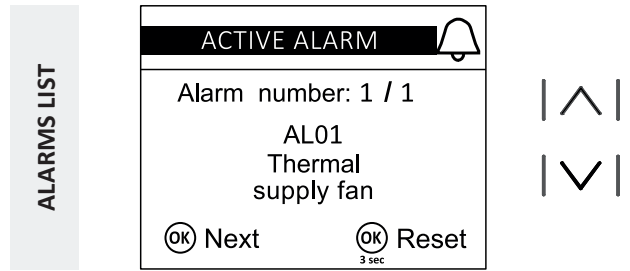

If there are several active alarms, they can be displayed in sequence by pressing the "UP" or "DOWN" keys.

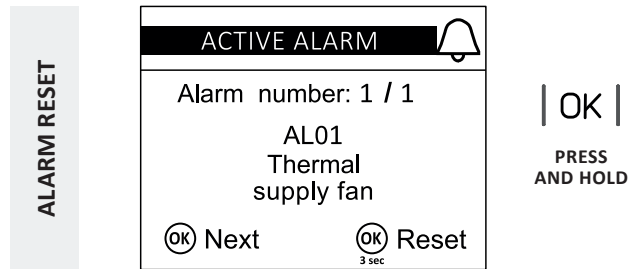

To reset an alarm, is enough to press the "OK" key on it.

Once reset all the alarms, the blinking icon of the "RED BELL" disappears and "NO ALARM" screen is displayed.

To go back to the main screen press the "ON / STAND-BY" key (simple pressure).

ATTENTION: automatic reset alarms reset themselves once the cause of the alarm has been removed.

19. DIAGNOSIS AND TROUBLESHOOTING

19.1 Troubleshooting

All units are checked and tested at the factory before delivery, however, it is possible that some anomaly or failure may occur during operation.



It is recommended to reset an identification alarm only after removing the cause that generated it; repeated resets may result in irreversible damage to the unit.

CODE	ALARM DESCRIPTION	RESET	CONSEQUENCE
AL07	Heater overheating alarm	Manual	Turns off all the heaters and forces the fans to 100%
AL08	Air filter pressure switch	Manual	Display only
AL13	Fire/smoke alarm ⁽¹⁾	Automatic	Turns off all devices
AL18	Ambient/return air sensor faulty or disconnected	Automatic	Disables regulations that depends on it
AL19	Supply air sensor faulty or disconnected	Automatic	Disables regulations that depends on it
AL20	Outdoor air sensor faulty or disconnected	Automatic	Disables regulations that depends on it
AL22	Exhaust air sensor faulty or disconnected	Automatic	Disables regulations that depends on it
AL23	Duct pressure sensor faulty or disconnected	Automatic	Disables regulations that depends on it
AL24	Air quality sensor faulty or disconnected	Automatic	Disables regulations that depends on it
AL28	I/O configuration error	Automatic	Turns off all devices
AL29	RTC faulty or disconnected	Automatic	Disabled time band management

⁽¹⁾ These alarms cause the turn off of the unit, putting it on the OFF by alarm status.

20. DIMENSIONAL DRAWINGS

(mod. 005-006-010-015-020)

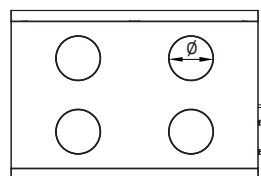
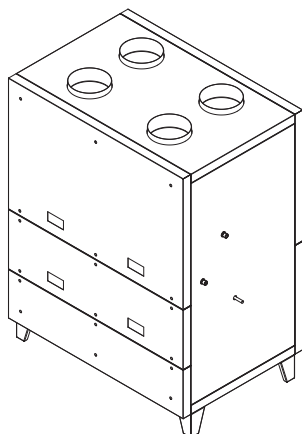
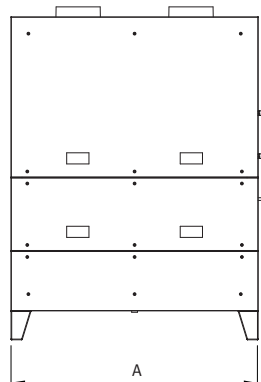
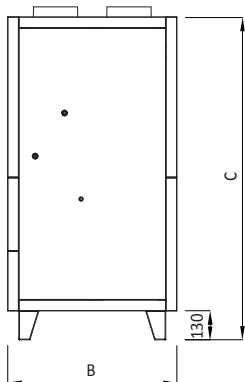

Due to the large number of configurations available, only general dimensional drawings are shown, which are to be considered purely indicative and may change without notice. The specific drawing of the ordered unit is present in the documents supplied with the unit itself.

GENERAL DIMENSIONAL DATA

MOD.	A [mm]	B [mm]	C [mm]	Ø [mm]	WEIGHT [kg]
005	745	670	1450	150	117
006	1110	760	1450	200	134
010	1345	760	1610	250	178
015	1345	1010	1800	250	226
020	1595	1000	1850	250	286

* Weight is referred to the main unit (without accessories)

(mod. 030-040)

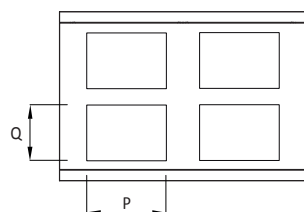
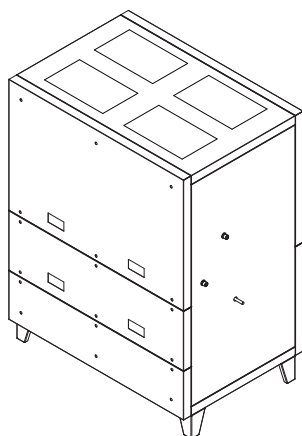
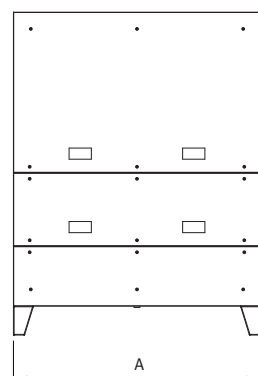
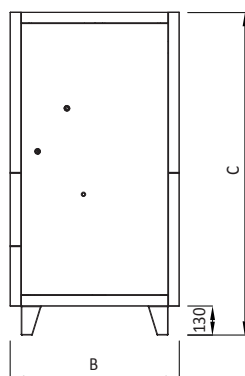

Due to the large number of configurations available, only general dimensional drawings are shown, which are to be considered purely indicative and may change without notice. The specific drawing of the ordered unit is present in the documents supplied with the unit itself.

GENERAL DIMENSIONAL DATA

MOD.	A [mm]	B [mm]	C [mm]	P x Q [mm]	WEIGHT [kg]
030	2110	1110	2110	450 x 350	338
040	2110	1110	2110	450 x 350	368

* Weight is referred to the main unit (without accessories)

21. UNIT MAINTENANCE

21.1 General warnings

Maintenance allows you to:

- Keep the unit efficient.
- Prevent possible breakdowns.
- Reduce the rate of deterioration of the unit.



It is advisable to provide a unit booklet with the purpose of keeping track of the interventions carried out on the unit, facilitating the potential search for faults.



The maintenance operations must be carried out in compliance with all the prescriptions of the previous paragraphs.



Use personal protective equipment as required by current regulations.

21.2 Access to the unit

Access to the unit once it has been installed must be allowed only to authorised operators and technicians. The owner of the machine is the legal representative of the company, body or natural person who owns the plant where the machine is installed. He is responsible for observing all the safety rules indicated in this manual and in the regulations in force.

21.3 Periodical checks



Commissioning operations must be carried out in accordance with all the requirements of the previous paragraphs.



All operations performed on the unit must be carried out by qualified personnel in compliance with the national legislation in force in the country of destination.

Every 6 months

It is good practice to carry out periodic checks to ensure that the unit, control and safety devices are functioning correctly.

- Check that the electrical terminals inside the electrical cabinet are secure.
- Periodically clean the mobile and fixed contacts of the contactors.
- Check that there are no water leakages in the hydraulic circuit..
- Check the condition of the finned coils, if necessary clean with compressed air in the opposite direction to the air flow. If the coil is completely clogged, clean it with a low-pressure cleaner, taking care not to damage the aluminium fins..
- Check the attachment and balance of the fans.

Unit shutdown

In case of long period shutdown, the hydraulic circuit must be drained so that there is no more water in the pipes and the exchanger. This operation is compulsory if, during the shutdown period, the ambient temperature can fall below the freezing point of the mixture used (typical seasonal operation).

22. DECOMMISSIONING

22.1 Disconnecting the unit



All decommissioning operations must be carried out by authorised personnel in accordance with the national legislation in force in the country of destination.

- Avoid spillage or leakage into the environment.
 - Before disconnecting the unit, recover any brine mixtures from the hydraulic circuit;
- Pending decommissioning and disposal, the machine can also be stored outdoors, provided that the unit has the electrical and hydraulic circuits intact and closed.

22.2 Decommissioning, disposal and recycling

The structure and the various components, if unusable, must be dismantled and sorted according to their nature. All materials must be recovered or disposed of in accordance with the relevant national regulations.

22.3 RAEE Directive (EU only)



- The RAEE Directive requires that the disposal and recycling of electrical and electronic equipment must be managed through a specific collection, in appropriate centres, separate from mixed urban waste.
- The user is obliged not to dispose of the equipment, at the end of its working life, as urban waste, but to comply with Directive 2012/19/EU at European level and with Legislative Decree 49/2014 at national level.
- Units covered by the RAEE Directive are identified by the symbol shown above.
- Manufacturer can supply additional information on request, in particular it will indicate the reference certification body according to RAEE.



VORTICE INDUSTRIAL S.r.l. si riserva il diritto di apportare tutte le varianti migliorative ai prodotti in corso di vendita.
VORTICE INDUSTRIAL S.r.l. reserves the right to make improvements to products at any time and without prior notice.
VORTICE INDUSTRIAL S.r.l. se réserve le droit d'apporter toutes les variations afin d'améliorer ses produits en cours de commercialisation.
VORTICE INDUSTRIAL S.r.l. behält sich vor, alle eventuellen Verbesserungsänderungen an den Produkten des Verkaufsangebots vorzunehmen.
VORTICE INDUSTRIAL S.r.l. se reserva el derecho a hacer cambios en los productos para su mejora en cualquier momento sin previo aviso.
VORTICE INDUSTRIAL S.r.l. 公司 股份有限公司 保留在产品销售期间进行产品改良的权利。

VORTICE GROUP COMPANIES

VORTICE S.p.A.
Strada Cerca, 2- frazione di Zoate
20067- Tribiano (MI)
Tel. +39 02-90.69.91
ITALY
vortice.com
postvendita@vortice-italy.com

VORTICE INDUSTRIAL S.r.l.
Via B. Brugnoli, 3
37063- Isola della Scala (VR)
Tel. +39 045 6631042
ITALY
vorticeindustrial.com
info@vorticeindustrial.com

VORTICE VENTILATION SYSTEM (CHANGZHOU) CO.LTD
Building 19, No.388 West Huanghe Road, Xinbei District,
Changzhou, Jiangsu Province CAP:213000
CHINA
vortice-china.com
vortice@vortice-china.com

VORTICE LIMITED
Beeches House-Eastern Avenue
Burton on Trent- DE 13 0BB
Tel. +44 1283-49.29.49
UNITED KINGDOM
vortice.ltd.uk
sales@vortice.ltd.uk

VORTICE LATAM S.A.
Bodega #6
Zona Franca Este Alajuela- Alajuela 20101
Tel. (+506) 2201 6934
COSTA RICA
vortice-latam.com
info@vortice-latam.com

CASALS VENTILACIÓN INDUSTRIAL IND., S.L.
Ctra. Camprodon, s/n
17860- Sant Joan de les Abadesses (Girona)
SPAIN
casals.com
ventilacion@casals.com